

Numeracy

Numeracy Handbook for Foundation Phase Teachers: Grades R-3

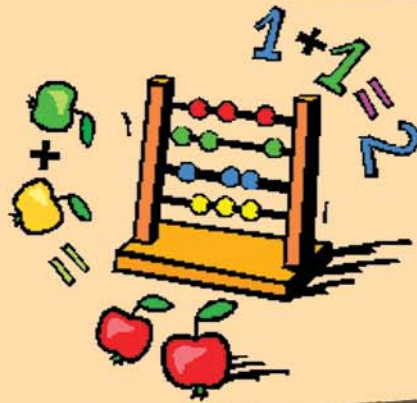

basic education

Department:
Basic Education
REPUBLIC OF SOUTH AFRICA

**Numeracy Handbook
for
Foundation Phase Teachers
Grades R–3**

**November 2012
(CAPS Edition)**



Department of Basic Education

Please address any responses you may have to:

Ms Chintia Maharaj (Chief Education Specialist, Foundation Phase)

Tel: +27 12 357 4123

Fax: +27 12 325 4001

e-mail: Maharaj.c@dbe.gov.za

Sol Plaatje House
222 Struben Street
Private Bag X895
Pretoria 0001
South Africa

120 Plein Street
Private Bag X9023
Cape Town 8000
South Africa
Tel: +27 21 465 1701
Fax: +27 21 461 1810

<http://www.education.gov.za>

<http://www.thutong.org.za>

© 2012 Department of Basic Education

Design and layout: Formeset Digital, Tshwane
Tel.: (012) 567 4337
Email: denise@formesetgroup.co.za



Message from the Director-General

This Numeracy Handbook has been developed by the Department of Basic Education to enhance the pedagogic and didactic capacity of Foundation Phase teachers to teach Mathematics more effectively in the early grades. It provides numerous teaching ideas on the teaching of the mathematical concepts and skills that are set out in the Curriculum and Assessment Policy Statement (CAPS).

The Handbook advocates a child-centred approach that encourages teachers to take cognisance of children's learning styles (visual, auditory and kinesthetic) and cognitive and developmental levels in the teaching and learning process. This Handbook is based on the premise that children must be exposed to concrete and kinesthetic learning experiences that will get them "to do, talk and record" their mathematical thinking. Emergent numeracy is strongly emphasised by:

- encouraging children to demonstrate their mental images with concrete objects or use of drawings and sketches;
- giving children the opportunity to explain their thinking to their peers and teacher; and
- encouraging children to record in writing the "story" of what their sketches show.

Numeracy is an essential building block for young children to make a confident start to Mathematics. Teachers are encouraged to draw on this resource as much as they can in order to plan stimulating activities that:

- start with real problems that present children with mathematics processes that are embedded in meaningful contexts;
- encourage children to present their mathematical thinking/understanding verbally and graphically with symbols of their own during the emergent numeracy phase; and
- involve children in a variety of dialogues that encourages them to reflect on their mathematical thinking.

I trust that this resource will prove to be an effective tool in the classroom.

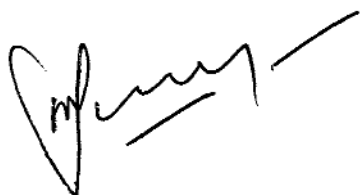

Mr PB Soobrayan
Director-General: Department of Basic Education
Date: 01/02/2013



Contents

Unit 1:	Introducing the handbook.....	1
Unit 2:	Developing numeracy – what do we know?	3
Unit 3:	Developing a strong sense of number.....	21
Unit 4:	The role of problem solving	57
Unit 5:	Numbers, Operations and Relationships	77
Unit 6:	Patterns	99
Unit 7:	Space and shape (Geometry)	113
Unit 8:	Measurement.....	127
Unit 9:	Data Handling	135
Unit 10:	Organising the Numeracy classroom	149
Appendices		
	Appendix A – Exemplars for planning and assessment	167
	Appendix B – Flard cards	176
	Bibliography	178



Unit 1: Introducing the handbook

Introduction

In order to be able to effectively participate in and contribute to the world in which we live requires that individuals must know “basic mathematics”.

The Numeracy Programme in the Foundation Phase is critical to developing both a sense of what mathematics is and what it means to do mathematics.

The results of both national and international studies reveal quite clearly that South African schools are failing our children in helping them develop the necessary skills to be able to “do mathematics”.

This handbook describes both what it means to do mathematics and provides guidance for Foundation Phase teachers on how to support children develop the required knowledge and skills.

This handbook is intended for use by the Foundation Phase Numeracy teacher. In this handbook you will find both a discussion of the important issues and recommendations for classroom practice.

The handbook has been divided into two parts:

- In Part 1, which consists of Units 2, 3 and 4, you will find a description of what it means to be numerate and do mathematics in the modern world. You will also find here a discussion of the critical factors that contribute to the development of numeracy.
- In Part 2, which consists of Units 5 to 9, you will find an analysis of each of the five content areas described in the Curriculum and Assessment Policy Statement (CAPS) that make up the South African Curriculum for the Foundation Phase. The content areas describe the key issues to be thought about when teaching the topics and suggestions for effective classroom practice.
 - ▶ Unit 10 (which belongs to the second part of the book) deals with issues of classroom practice. This unit is presented in the form of answers to a number of frequently asked questions that range from the role of mental mathematics to planning and assessment.

It is recommended that the book be read over time. The Units in Part 1 will provide valuable insights into the thinking that informed the development of the curriculum as well as guidance on the development of a **strong sense of number** and the role of problems in teaching Numeracy. The Units in Part 2 help the reader to more effectively interpret the curriculum while at the same time demonstrating how the ideas of Part 1 can be translated into classroom practice.

About the handbook

In this handbook mathematics is regarded as a tool for solving problems and being successful in mathematics as:

- **Understanding** what you are doing;
- As you **apply** what you know to solve unfamiliar or non-routine problems; and
- Being able to **reason** about what you have done.

We want children to experience Numeracy/Mathematics as a purposeful, meaningful and sensible activity. For this reason we regard problem solving both as a reason for learning mathematics and solving problems as a way of learning how to do mathematics (see Unit 4).

Critical to being able to “do mathematics” is the development of a strong sense of number (see Unit 3). Children who leave the Foundation Phase with a poorly developed sense of number are almost certainly unable to ever make sense of mathematics.

CAPS in each of the content areas describes the knowledge and skills that children should develop throughout their school career. However, many teachers struggle to translate the curriculum into practice. The detailed discussion of each Learning Outcome complete with suggestions for classroom practice should help the teacher to translate the ideas described in the early part of the book into classroom activities.



Introduction

For people to participate effectively in society they must know and be able to use basic mathematics. People who do not have a grasp of basic mathematics are excluded from effective participation in society – mathematics is a very powerful gatekeeper.

The availability of the hand-held calculator has changed the kinds of mathematics that people need to know and learn. For the parents and grandparents of today's children, learning mathematics involved learning how to calculate.

For the children of today, learning mathematics means learning how to use tools such as calculators to make decisions and solve problems in addition to being able to calculate.

Today's child needs to learn a different mathematics to the mathematics that their parents learnt and they need to learn it in a different way.

All children must learn to think mathematically and they must think mathematically to learn mathematics.

Adding it Up: helping children learn mathematics (NRC, 2002)

For children to be able to use and apply the mathematics they learn at school, they need to experience it as a meaningful, interesting and worthwhile activity. The importance of the Foundation Phase (Grades R–3) cannot be underestimated. In the Foundation Phase children either develop a love for the subject or a fear of it – the role of the teacher cannot be underestimated.

Performance by South African children in the national systemic evaluations (DoE) as well as in regional (SACMEQ) and international (TIMSS) studies suggests that they are not thinking mathematically.

An analysis of the SACMEQ and TIMSS test items reveals that more emphasis is placed on children being able to “think mathematically” than on children being able to calculate. However the emphasis in the teaching and learning of Mathematics in schools across our country continues to focus on basic calculation algorithms.

While it is critical for children to:

- Be able to perform the basic operations;
- Know their basic number facts; and
- Perform mental arithmetic with confidence,

this alone is not enough. Children need to understand the mathematics that they learn in flexible and meaningful ways so that they can apply it with confidence to make sense of the world. That is, to solve problems.

Although there is agreement across the board that we want improved performance in mathematics for and by all of our children, in particular among those children who have historically been denied access to mathematics; there may not be the same agreement on:

- How this improvement is to be achieved, or
- What it means to be able to think mathematically.

In this Unit we will describe some of the more recent thinking about the teaching and learning of mathematics. We will also discuss the implications of this for developing Numeracy in the Foundation Phase.

What we know

The challenge for all Numeracy teachers is to answer the question:

How do I teach in a way that will help children to think mathematically?

In order to develop a response to this question we will introduce a number of ideas. In particular we will consider the following:

- The notion of different kinds of knowledge:
 - ▶ Physical knowledge
 - ▶ Social knowledge
 - ▶ Conceptual knowledge (also referred to as *logico mathematical knowledge*) as described by Piaget.
- The notion of *Mathematical Proficiency* incorporating the five strands:
 - ▶ Understanding
 - ▶ Applying
 - ▶ Reasoning
 - ▶ Engaging
 - ▶ Computing
 as described in *Adding it Up: helping children learn mathematics (NRC, 2002)*.
- The levels of geometric thinking:
 - ▶ Visualization
 - ▶ Analysis
 - ▶ Abstraction
- and the associated sequence of teaching activities:
 - ▶ Free play
 - ▶ Focused play
 - ▶ Vocabulary
 - ▶ Further focused play



- ▶ Consolidation as described by van Hiele for the Foundation Phase.

In light of these ideas we will introduce the three crucial factors to be considered when developing Numeracy in the Foundation Phase:

- The development of a strong number sense;
- The use of meaningful problems; and
- Discussion

In the later chapters of this handbook we will demonstrate how the:

- Kinds of knowledge;
- Elements of mathematical proficiency;
- The levels of thinking and associated teaching activities (van Hiele); and
- The three critical factors for developing Numeracy are all reflected in the National Curriculum Statement.

Three kinds of knowledge

There are three kinds of knowledge:

- Physical knowledge
 - Social knowledge
 - Conceptual knowledge (also referred to as *logico mathematical knowledge*)
- Each of these is important in the development of the child in general, and the child's mathematics in particular. There is no hierarchy among these kinds of knowledge and the three support each other.

Physical knowledge



Physical knowledge is derived through touching; using; playing with; and acting on concrete/physical material.

Children need a lot of concrete experiences in the numeracy classroom to develop their physical knowledge of:

- **Number**
It is through counting physical objects that children:
 - ▶ Experience that two objects is different to three objects; and

Physical knowledge in everyday life

When an adult and a very young child each carry a cup of tea, the child, in comparison to the adult, will almost certainly find the task quite difficult.

The child will need two hands to hold the cup and will concentrate on the contents of the cup taking one uncertain step after another.

- ▶ Develop a sense of the size of numbers: 50 takes longer and more actions to count than 5 does but 250 takes a lot more. Five counters can be held in one hand; 50 in two hands; and 250 require a container – there are too many for our hands.

- **Patterns**

It is through copying and extending patterns using matchsticks, tiles, blocks and other apparatus that children develop a sense of behaviour of patterns and learn to make predictions.

- **Space and Shape**

It is through handling concrete shapes and completing tasks such as:

- ▶ Building objects;
- ▶ Covering (tiling) surfaces; and
- ▶ Making new shapes and objects

that children develop a sense of the relationships and properties of the shapes and objects that they are working with. They develop a sense of:

- ▶ Equal – equal length sides; equal angles; equal areas; and
- ▶ Unequal – bigger and smaller; more and less.

- **Measurement**

It is through measuring, first informally and then formally, that children develop a sense of the “muchness” of things. Through measuring they also meet up with situations which cause them to think about the need for parts of a whole to describe certain quantities – an important introduction to the concept of fractions.

- **Data**

It is through the collecting and sorting of physical objects that children develop their first sense of what it means to work with data.

In order to develop **physical knowledge** the Foundation Phase Numeracy classroom should provide both concrete apparatus (counters, shapes such as building blocks and other construction materials, measuring apparatus etc) and the opportunity for children to work/play with the apparatus.

The adult, by contrast, will be able to pick up the cup with one hand and carry it with confidence and be able to maintain a conversation while walking at speed.

The difference between the two is that the adult has carried cups for many years. She has developed a sense of the “cup-ness” of the cup – we refer to this as her physical knowledge of the cup. The adult knows how the cup behaves.

The important message is that the adult has developed this sense of the cup through handling cups over an extended period of time, not from lectures and not from reading a text on cups.

It is the teacher’s responsibility to provide both the concrete apparatus and the time for children to work with it.

There is a very good chance that those children who:

- Do not develop a strong sense of number were not given sufficient opportunities to count concrete objects (see Unit 3: Developing a sense of number);
- Struggle with space and shape concepts later in life were not given opportunities to play/work with building blocks and other apparatus at an early age.

Social knowledge

We refer to knowledge that needs to be told to people and remembered by them as social knowledge. The only way in which we can acquire social knowledge is to be told it and having been told it we need to remember it.

The implication of social knowledge for the numeracy classroom is that teachers have to tell (teach) children this knowledge. For example teachers need to teach children:

- Vocabulary such as:
 - ▶ Number names;
 - ▶ The names of shapes and objects; and
 - ▶ The words that we use to describe operations. Children can perform the “basic operations” without any knowledge of the words “addition, subtraction, division and multiplication”. It is the role of the teacher to help children develop the language with which to describe their activities.

When a mother asks her child to help her in the kitchen and says “I need 8 potatoes altogether, I already have three here, please get me the rest” then the child will respond to the question in one of two ways, either she will count on: “four, five, six, seven, eight” touching the potatoes while counting or she will count out eight potatoes from the packet and put three back. The first action could be called addition while the second subtraction.

- Conventions such as:
 - ▶ The way in which we write the number symbols;
 - ▶ The way in which we write a number sentence to describe problems; and
 - ▶ The way in which we use the equal sign to denote equivalence.

Social knowledge in everyday life

The number **five** is an easy concept for an adult who has known and used the word for many years. They can imagine five items and can calculate with five without having to recreate the number using physical counters or representations in their minds.

If we take a moment to reflect and think about this then we realise that there is nothing about the word five that hints at the number of items it represents.

So it is with people’s names, place names, days of the week and months of the year. The words we use to describe these are all “names” that we have assigned. Because the people in our community (society) all associate the same thing with the same name (word) we are able to communicate with each other.

In order to know these names (this social knowledge) we need **to be told** them and **to remember** them.

Social knowledge is not limited to vocabulary it also applies to social conventions. In our country we drive on the left hand side of the street – this is a convention: it is a decision that we have taken. Of course there are implications that this decision has had including that our cars have their steering wheels on right hand side of the car.

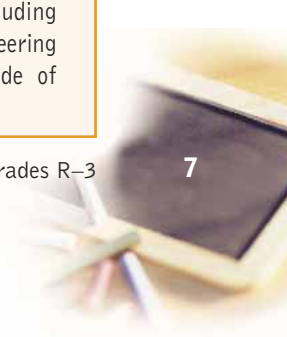

While there is a certain body of social knowledge that teachers must teach, there is a greater body of knowledge that children can extract for themselves from appropriate activities (see conceptual/logico-mathematical knowledge below).

When, however, teachers teach conceptual knowledge as social knowledge they create a number of difficulties. For example when a teacher “teaches” her class the “rules” that:

- Multiplication makes bigger and division makes smaller; and
- You always subtract the smaller number from the bigger number then they are:
 - Adding to the list of things to be remembered by the child;
 - Likely to be misinterpreted because the child applies the rule quite literally – as can be seen in the typical subtraction error alongside; and
 - Introducing rules that, in any case, have limited application:
 - ▶ In the case of *always subtracting the smaller number from the larger* this only holds when we are working with positive numbers; and
 - ▶ In the case of *multiplication making bigger and division making smaller* this only holds when we are working with whole numbers.

$$\begin{array}{r} 23 \\ -18 \\ \hline 15 \end{array}$$

Conceptual knowledge

When children reflect on activities and see:

- Patterns;
- Relationships;
- Regularities and irregularities;

they are constructing what is known as conceptual (logico-mathematical) knowledge.

Conceptual knowledge is internal knowledge. It is constructed by each individual for themselves.

The teacher’s role in the development of children’s conceptual knowledge is two-fold. The teacher:

- Is responsible for creating activities for children that will reveal the underlying structures of numbers, operations, and mathematical relationships.
- Needs to actively encourage children to reflect on what they are doing and what they are thinking. The teacher must help children to verbalise their observations so that they can explain these to the other children as well as learn to interpret the explanations of the other children (see Assessment Standards Learning Outcome 1).

Since conceptual knowledge is constructed by individuals based on their experience with situations the most important task of the teacher is to design situations and plan activities from which children can construct their conceptual knowledge.

When designing a lesson/task; the teacher needs to ask the question:

What do I want children to learn from this situation/problem/activity?

Having established the desired outcome of the lesson/task the teacher then needs to shape the situation/problem/activity in a way that will invoke children to “see” the patterns and structures.

Furthermore, both during and on completion of the activity, the teacher needs to facilitate reflection on the activity by the child. It is this reflection more than anything else that will support the development of conceptual knowledge.

Children who are at Level 3* in terms of their number development are children who are able to break **down and build up numbers** in a range of different ways.

“Completing tens (or hundreds)” is an important skill that children need to develop in order to break down and build up numbers with confidence.

To support children in developing this skill a teacher might ask her class to complete a number of flow diagrams such as the one alongside. The teacher wants the children to observe the pattern: “adding a seven to a number ending in 3; completes the ten”.

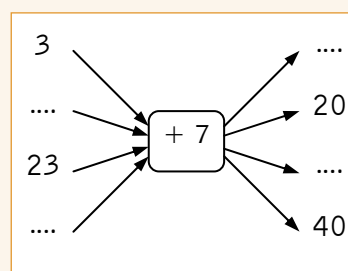

By asking children “what did you do to complete this task so quickly?” the teacher is encouraging reflection on the task and the children will observe patterns and come to realise their value.

More generally, after a number of these activities, children will come to realise that since:

- $1 + 9 = 10$;
- $2 + 8 = 10$;
- $3 + 7 = 10$; etc

in general when we add:

- 9 to any number ending in 1
 - 8 to any number ending in 2
 - 7 to any number ending in 3
 - etc
- } we complete the ten

These children are developing patterns that will enable them to work flexibly and confidently in a way that avoids the need to remember a large number of facts.

While it is tempting to think that we can make life easier for children by simply “telling them the rule” such an approach:

- Creates a lot of rules to be remembered; and
- Leads to confusion and errors if the rules are misunderstood/misinterpreted or forgotten.

* Level 3 number sense is discussed in Unit 4 (Developing a strong sense of number).

Reader's reflection

Some classroom situations are described below. Answer the questions that follow:

Counting

Ms Nxolo asks the children in her class to count (chanting number names) as a class from 1 to 120.

Ms Damonse asks the children in her class (individually) to count the number of objects in a pile by touching each object as they count it.

Question:

What kind(s) of knowledge are the children in each of these classes developing?

Number patterns

The children in Ms Higg's class are determining the values of $18 - 9$; $15 - 9$; and $13 - 9$. In order to help them she reminds them of the rule that she had already taught them: "When we subtract 9 from 18 we add the 1 and the 8 to get 9 – this is our answer. Similarly when we subtract 9 from 15 we add the 1 and the 5 to get 6 – this is our answer. ..."

The children in Ms Julie's class have been given the flow diagrams alongside to complete. Once all the children have finished Ms Julie leads a discussion on what the children noticed while completing the task.

Question:

Which teacher is treating the knowledge to be developed by means of this task as social knowledge and which is treating the knowledge as conceptual knowledge?

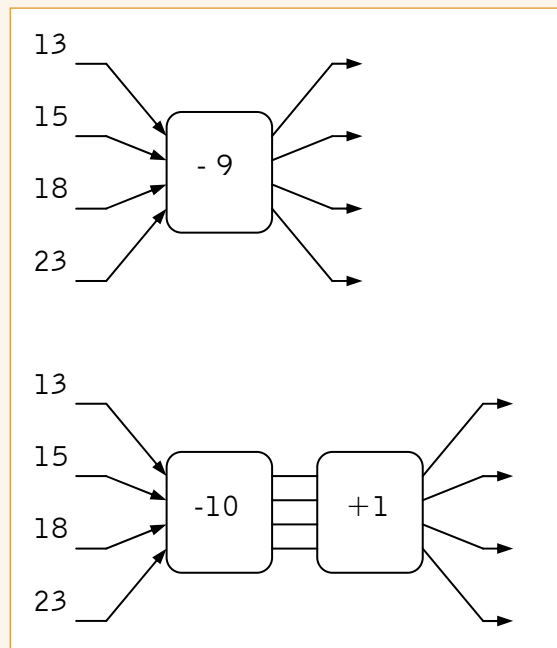

The strands of Mathematical Proficiency

Mathematical Proficiency is a term used by the authors of *Adding it up: helping children learn mathematics* (NRC, 2001) to describe:

“what it is to be successful in mathematics”

Being mathematically proficient (numerate) means:

- **Understanding** what you are doing (conceptual understanding);
- Being able to **apply** what you have learnt (strategic competence);
- Being able to **reason** about what you have done (adaptive reasoning);
- Recognising that you need to **engage** (productive disposition) with a problem in order to solve it; and of course
- Being able to **calculate/compute** (procedural fluency) with confidence.

Understanding

Understanding is the comprehension of:

- Mathematical concepts;
- Operations and relations; and
- Knowing what mathematical symbols, diagrams and procedures mean.

Understanding refers to an individual’s ability to make sense of and use basic mathematical ideas in a range of situations.

To understand is to know more than how to perform procedures and/or recall facts. To understand is to be able to relate and use different mathematical ideas in solving problems.

When children learn with understanding they have fewer things to remember. Children who learn with understanding know that 3×5 is the same as 5×3 and that the four times table is simply double the two times table.

Learning with understanding also provides support to remembering and being able to use mathematical facts and procedures in unfamiliar situations.

The implication for teaching is that we need to provide children with the opportunity to make sense of and reflect on procedures and practices so that they can develop deep **conceptual understanding**.

Learning without understanding contributes to so many of the problems experienced by children in numeracy classrooms.



Applying

To apply is to be able to express problems mathematically and to devise strategies for solving them using appropriate concepts and procedures.

Applying relies on:

- using **understanding** and efficient **computational skills** to solve a problem; and
- knowing which mathematical procedures to use and being able to use them fluently and efficiently to solve a problem.

The implication for teaching is that children need to be exposed to non-routine problems in which they have to apply the knowledge and skills that they have developed.

Reasoning

Reasoning is central to the development of mathematics and mathematical proficiency.

Children must reflect on and think about how they solved a problem or completed a task. Reflection on their actions contributes to the development of **conceptual knowledge**.

It is through reasoning that children develop their understanding of the task in hand and come to see mathematics as sensible and doable.

The implication for teaching is that teachers need to encourage reflection through classroom discussion (see **conceptual knowledge** above). To be clear, discussion will often focus on children simply explaining their thinking.

Applying is using **understanding** and **computing skills** to solve non-routine problems: problems for which the method is neither obvious from the way in which the problem has been posed and/or apparent as is the case when a problem is familiar.

Completing the table below requires that children apply their knowledge of number and number properties.

\times	<u>3</u>	<u>5</u>
<u>2</u>	<u>4</u>	<u>8</u>
	<u>18</u>	<u>30</u>
<u>7</u>	<u>28</u>	
	<u>27</u>	<u>45</u>

Reasoning is using logic to explain and justify a solution to a problem or to extend from something known to something not yet known.

Zintle

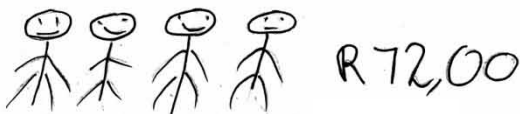

$$10 + 10 + 10 + 10 + 10 + 10 + 10$$

$$70 - 40 = 30$$

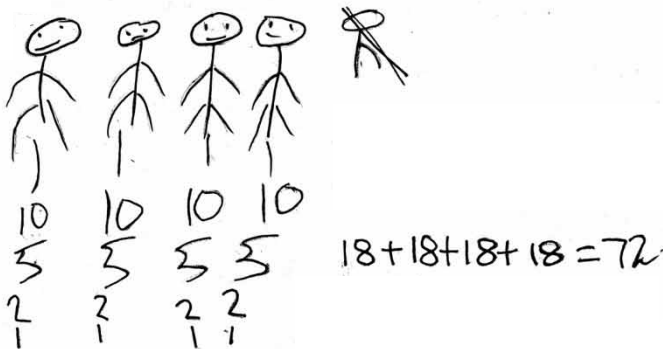
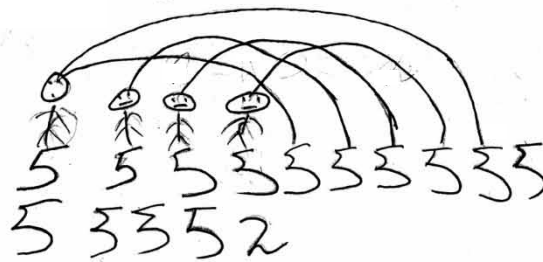

Zintle's work alongside illustrates what can happen when a child can reason.

Zintle (Grade 2) is solving the problem: 4 children are paid R72 altogether. If they share the money equally between themselves, how much will each person get?

Zintle drew 4 children and started by giving each child R10.

She then established that there was still R30 left over.

She reasoned that there is not enough money to give each child another R10, so she started again and tried to share out the money using amounts of R5.

She wrote 5 beneath each child and then connected each child with another 5.

When she started to give each child a third R5, she realised that she had actually given each child R10 already and that there would be enough 5's for another round.

She then started all over again, giving each 10, then 5 and then 2 and lastly 1 each.

So every child got R18

Finally she checked that the $18 + 18 + 18 + 18$ is in fact R72.

Through careful reasoning Zintle was able to establish that $72 \div 4 = 18$

Engaging

Children who engage, use their understanding of the mathematics that they have learnt to solve meaningful problems. They do so knowing that they may have to struggle and try a few different approaches before the problem is solved. They believe that with some effort they can solve the problem.

To engage is to see mathematics as sensible, useful, and doable – if you work at it – and are willing to do the work.

Children who by contrast experience mathematics as a set of rules and instructions to be remembered and reproduced on demand without understanding, become removed and regard mathematics as meaningless and difficult.

The implication for teaching is that teachers need to demonstrate their faith in the ability of the children in their class to solve problems – providing the necessary support without taking away the independence of the child.

Computing

Computing involves being able to perform the procedures for the basic operations:

- adding;
- subtracting;
- multiplying; and
- dividing

both mentally, and by means of paper and pencil and/or even a calculator.

To compute means to perform mathematical procedures, such as adding, subtracting, multiplying, and dividing numbers: flexibly, accurately, efficiently, and appropriately.

The same applies to the procedures used in other areas of numeracy such as using measuring instruments in measuring and constructing a graph in data handling.

In order to be able to compute effectively children need:

- A strong sense of number (see Unit 4);
- To know the how to perform a range of operations fluently and easily; and
- To do so quickly and correctly.

Understanding and **computing** are not opposites as in “either we teach for understanding or we teach children how to compute”. They support each other. Understanding makes it easier to learn skills while learning procedures can strengthen the development of understanding – it is often through **doing** that we develop a sense of what it is that we are doing.

The implication for teaching is that teachers need to support their children in developing a strong sense of number (see Unit 4) and that they need to help children develop their computational strategies in ways that makes sense to them (see Unit 5).



Awareness of the strands of mathematical proficiency helps teachers in two ways:

- They remind teachers that teaching mathematics is much more than the teaching of methods or procedures only. Teaching mathematics involves helping children to **understand**, to **apply** and to **reason** about and with the mathematics that they learn.
- They allow teachers to answer the question: “Am I doing the right thing?” If the children in your class are **willing** and **able** (i.e. engaging) to **apply** their mathematical knowledge with **understanding** to solve non-routine problems and **justify** their solution method(s) they are becoming numerate/mathematically proficient.

The van Hiele levels of geometric reasoning and a related teaching sequence

Pierre van Hiele observed children developing geometric reasoning and provided a description of the levels through which they evolve, from recognising figures to being able to develop formal proofs.

He identified five levels which he called:

- visualisation;
- analysis;
- abstraction;
- deduction; and
- rigour.

Two things should be noted about these levels:

- They are age independent. Any person at any age who is developing geometric understanding will move through the levels.
- It is not expected that children will move much beyond the abstraction level until they are well into their teenage years. In other words there is little expectation that children will, in the Foundation Phase, reach the deduction and rigour levels.

Visualisation

Children at the visualization stage of their development can recognise figures based on their appearance alone. They will say: “it is a square because it looks like a square”.

A Foundation Phase child who is given a pile of shapes can easily sort them in different ways. However, when they are asked to describe the criteria they used to sort the shapes, they can do little more than to say that the shapes in each pile belong together.

Analysis

Children at the analysis stage of their development can recognise and name properties of figures although they do not necessarily see any relationship between them.



They may notice that a triangle has three sides and also that a triangle has three angles or vertices and yet will not see any relationship between these two observations.

Abstraction

Children at the abstraction stage of their development start to perceive the relationships between the properties of the figures with which they are working. They start being able to make meaningful definitions and to give informal arguments to justify their thinking.

It is not expected that many Foundation Phase children will reach the level of abstraction.

Deduction and rigour

Although we do not expect children in the Foundation Phase to reach these levels, they are described here for completeness.

At the deduction level of thinking children can construct proofs with an understanding of the roles of axioms and definitions and they understand the meaning of necessary and sufficient conditions.

At the rigour level, children begin to understand formal aspects of deduction and can develop both indirect proofs and proofs by contradiction.

In addition to identifying and describing the levels of geometric thinking van Hiele developed a description of the different components of a geometry learning experience which support children's development:

- Free play;
- Focused play;
- Vocabulary;
- Further focused play; and
- Consolidation.

Although the van Hiele levels and teaching sequence were developed with respect to geometry, they are applicable to the teaching and learning of numeracy in general.

Although these components of the teaching sequence are presented sequentially, in practice the teacher will move forwards and backwards between them.

Free play

Free play or inquiry refers to activities in which children are supplied with materials and given the opportunity to “play” with them. They explore (informally) and become aware of some of the structures/properties of the figures and objects that they are working with.

Focused play

During focused play (described by van Hiele as guided or direct orientation), the teacher **poses a problem** that is intended to have the children focus on aspects/properties of the figures with which they are working.

Vocabulary

At certain times during the lesson it is necessary to provide children with the vocabulary that is used to name the pieces and the properties of the pieces with which they are working. In other words the teacher introduces the **social knowledge** (for example the names of the shapes and words such as edge, vertex or corner and angle.)

It should also be noted that children can engage in both the free and focused play activities without, at first, using formal vocabulary. Teaching does not have to begin with vocabulary – this can be introduced as and when needed. This is the same as the observation made earlier; namely, that children can solve problems without at first being aware that what they are doing is called addition or subtraction etc.

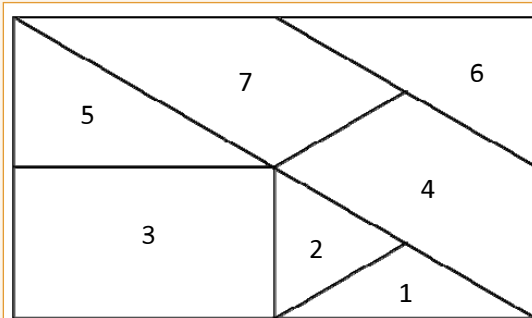

In an article that van Hiele wrote for primary school teachers he illustrates the notion of free play by suggesting that children be given the puzzle above cut up into the seven pieces and asked: “What can you make with these pieces?”

Different children will create different pictures such as the man alongside.

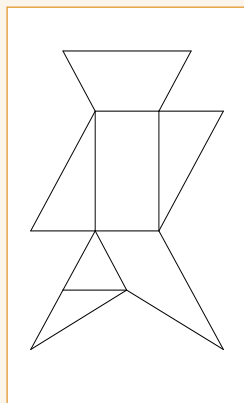

What should be noted is that in order to create their picture they have started developing a sense of the structure of the figures because they will have had to match sides and so on.

In shifting to **focused play** van Hiele suggests that the teacher could make the children aware of how, during the earlier activity, they may have joined two pieces together to make another. For example they may have joined pieces 5 and 6 together to make piece 3.

The teacher now poses the problem: “Which of the pieces can be made using two of the other pieces?” Or she may ask the children to investigate how many different shapes can be made by joining two pieces together – for example six shapes can be made when joining pieces 5 and 6 together.

In order to answer these question children will have to grapple with issues of size (lengths and angles), sameness and difference.

More focused play

Throughout the Foundation Phase children are continually set tasks/problems that invoke them to become aware of the features of the shapes and objects with which they are working.

These tasks and problems provide children with the opportunity to develop their **conceptual** knowledge.

Integration

Throughout the lesson children must be given the opportunity to reflect on:

- their actions;
- their thinking;
- the properties of the materials with which they have been working; and
- the solutions they have developed to the problems posed.

In doing so they summarise and integrate what they have learned – they are consolidating their **conceptual knowledge**.

Van Hiele's work is important for two reasons:

- The work can be extended beyond the development of geometric thinking to the development of numeracy in general.
- The components of a learning experience described above provide a helpful image of teaching numeracy:
 - ▶ **Free play** talks about providing opportunities for children to develop **physical knowledge**;
 - ▶ **Focused play** (and **more focused play**) reminds us of the need to *deliberately* set tasks and **problems** that will allow children to develop their **conceptual knowledge**;
 - ▶ The development of **social knowledge** is supported by the introduction of **vocabulary**; and
 - ▶ **Integration** reminds us of the important role of the teacher in facilitating discussion which encourages children to **reason** and in so doing to develop their **conceptual knowledge**.

Guidelines for practice

Describing:

- Piaget's work on different kinds of knowledge;
- Van Hiele's work on levels of geometric thinking and a teaching sequence that supports the development of these levels; as well as
- The components of *mathematics proficiency*

This unit has provided a framework within which to talk about the effective development of Numeracy in the Foundation Phase.

In light of this framework it is possible to identify three crucial factors to be considered when developing Numeracy in the Foundation Phase:

- **The development of a strong number sense (see Chapter 3);**
 - ▶ Without a strong sense of number children are unable to **compute** effectively and/or to **apply** their knowledge to solve problems in a meaningful way.

- **The use of meaningful problems (see Chapter 4);**
 - ▶ Problems play three key roles in the development of numeracy:
 - They introduce children to the basic operations;
 - They support the development of computational strategies; and
 - They make the mathematical experiences of the child both meaningful and relevant.

- **Discussion**
 - ▶ Without reflecting on the work that they have done and the explanations of their peers, children will not develop the conceptual knowledge that is needed to be numerate.



Introduction

Having a strong **sense of number** underpins all development in numeracy. A strong sense of number means that an individual has:

- A sense of the size or “muchness” of a number:
 - ▶ they have a sense that 25 is larger than 5 and 500 is much larger;
- The ability to:
 - ▶ break a number down (decompose);
 - ▶ reorganise it; and
 - ▶ build it up again (recompose)

in a range of different ways. For example they can think of 68 as:

- $60 + 8$ and as $70 - 2$;
- as 34×2 and as $50 + 18$;
- as $20 + 20 + 20 + 8$ and as $100 - 30 - 2$
- The ability to use more sophisticated computational strategies when solving problems; and
- The ability to apply their knowledge of numbers to solve problems.

There are many examples of children at fairly advanced ages still using stripes to perform calculations and/or solve problems. Such children have a poorly developed sense of number. This weak number sense prevents them from being able to advance in a significant way in their mathematical development.

Children who leave the Foundation Phase with a weak sense of number will almost certainly never become strong in mathematics.

One of the most critical things to be achieved in the Foundation Phase is the development of a strong sense of number.

What we know

A strong sense of number is the foundation of all mathematical activity.

The key challenge of the Foundation Phase classroom is to assist children to develop a strong sense of number.

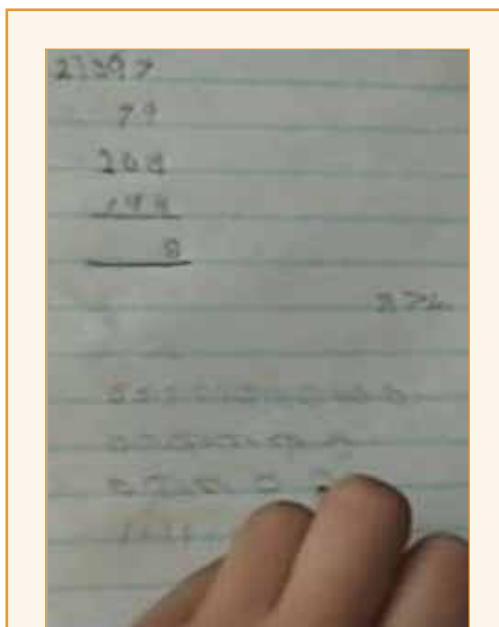

The Grade 4 girl in this illustration looks as if she is adding two and three digit numbers using a column algorithm. However if we look carefully then we see that she has reconstructed the numbers/digits in the second column using marks (circles and stripes) in order to “add” them. This girl’s sense of number is age inappropriate.

A child's sense of number develops through three levels with the levels following one after the other:

- Level 1: Counting all
- Level 2: Counting on; and
- Level 3: Breaking down and building up numbers

Level 1: Counting all

Children at Level 1 are **counting all**. When we ask a child who is operating at Level 1 to add two numbers then they will first recreate each number using fingers or other representations.

As the numbers get larger and the child can no longer rely on the fingers of their two hands to create the numbers, they will use either objects such as counters or bottle tops or they will reconstruct the number on paper by drawing stripes or circles.

When we ask a child who is at Level 1 to add to number, for example solve the problem: *There are three girls at the party, another five arrive: how many girls are there now?* The child might use the fingers of one hand to create the 3: "one, two, three" raising a finger for each number as they count out. They might then use the fingers of the other hand to create the 5: "one, two, three, four, five" again raising a finger for each number they count out. Having created both numbers in this way the child will then count all of the raised fingers: "one, two, three, four, five, six, seven, eight" and give 8 as the solution.

Level 2: Counting on

Children at Level 2 are **counting on**. When we ask a child who is operating at Level 2 to add/subtract two numbers then the child is able to conceptualise at least one of the numbers without having to recreate it, and recreates only the other number.

As the numbers get larger and the child can no longer rely on the fingers of their hand to create the number(s) they will also resort to using objects or drawings.



Level 3: Breaking down and building up numbers

Children at Level 3 are able to work with numbers in flexible ways often **breaking numbers down (decomposing), reorganising them and then building them up again (recomposing)** in order to solve a problem.

Children at Level 3 are said to have a “numerosity” of the numbers with which they are working – that is, they have a sense of the “muchness” of the numbers and can think of those numbers in a large range of different ways.

It can be expected that children will be able to **decompose and recompose numbers** (Level 3) for smaller numbers while they are still **counting on** (Level 2) and/or **counting all** for larger numbers.

Although in general we might expect more Grade 3s to be working at Level 3 than say Grade 1s; we would expect Grade 1s to achieve Level 3 skills for smaller numbers but to still be working at level 1 for larger numbers*. By Grade 3 we would expect most children to be able to work at Level 3 for all of the numbers*.

*appropriate to the Grade (see LO1 NCS)

$$94 = 20 + 20 + 20 + 20 + 10 + 2 + 2$$

$$94 - 66 = 28$$

This is Sanele’s solution to the problem: *Ben had 94 marbles. After losing some marbles he has 28 left. How many marbles did Ben lose?*

When asked to explain her thinking Sanele explained that she wrote $94 = 20 + 20 + 20 + 20 + 10 + 2 + 2$ and then said (pointing):

$$94 = 20 + 20 + 20 + 20 + 10 + 2 + 2$$

“Ben had 28 marbles left over so that is 20 [placing a finger over the 20], plus 2 [placing a finger over the 2], plus 2 [placing a another finger over the other 2] ... 24, when I take the remaining 4 from the 10, I am left with 6 ... so Ben lost 6 plus 20 plus 20 plus 20 ... 66 marbles

Sanele has a Level 3 sense of number. She is able to decompose the number in a manner that suits the problem she is working on and is then able to solve the problem building up her answer.

Below are three childrens' solutions to the same problem. They each demonstrate a different level of number development.

Pat and Lee made 52 cookies altogether. If Pat made 31 of them, how many did Lee make?



Xola draws 31 biscuits and then continued to draw cookies until she reaches 52. Next she counted the number of extra cookies and wrote down her answer of 21

Xola demonstrates a **Level 1** number sense – she had to **count all**.

A hand-drawn solution on a piece of paper. The number '31' is written on the left, followed by a horizontal dotted line, and the number '21' is written on the right.

Sandla wrote down 31 and counted on up to 52. He then counts how many extra cookies were needed – 21

Sandla demonstrates a **Level 2** number sense – he did not have to construct the 31 again – he simply **counted on**.

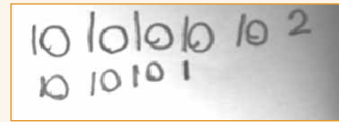

Lwazi broke the 52 into five tens and two and the 31 into three tens and one. He still has to determine the number of cookies baked by Lee.

Lwazi demonstrates a **Level 3** number sense – he did not construct either number – instead he simply **broke the numbers down in order to rearrange them and build up again**.

Two kinds of counting

Most children are introduced to number through counting. It is important to make the distinction between two different kinds of counting:

- **rote counting;** and
- **rational counting.**

Rote counting is what children do when they chant/sing numbers in sequence.

Parents and teachers often believe that their children are able to count when they can recite the number names in sequence from one to twenty and beyond – this is not the case. Although it is true to say that they can recite the numbers, these children do not (yet) see any relationship between the number words and a quantity of items. It is as if they are reciting the lines of a poem or the words of a song without having any sense of what the words mean.

A child who counts: *one, two, three, four ... fifteen, sixteen, twenty-two, thirty-nine ...* simply does not know the rhyme beyond (in this case) sixteen.

It is important that children are able to rote count – through rote counting they develop their knowledge of the number names (i.e. their **social knowledge** of numbers) and also a sense of the rhythm/pattern that is within numbers. For example they get a sense that

any sequence ending in 8 and then 9 is always followed by the next decade and within each decade the sequence is always: *1, *2, *3, *4, *5, *6, *7, *8, *9. Just as the sequence of the decades is: 10, 20, 30, 40 etc.

Rational counting involves the counting of physical objects. It involves matching the number names to objects. It is only through rational counting that children can develop a sense of the **muchness** of a number – that is; they develop the sense that 25 is more than 5 and 500 is much more than 25.

Rational counting activities help children to develop their early sense of number.

Rational counting involves touching objects one by one and simultaneously saying the numbers from the number rhyme in sequence.

Adults have a well developed sense of the meaning of say 5. When they hear 5 they automatically have a sense of “how many” and can work with that – *five people coming to dinner means...*

Adults are also able to calculate with the 5: they **know** that $5 + 3 = 8$ and they know this without having to reconstruct the five or the three. This is because the numbers have taken on meaning – meaning that has developed over time. By contrast children do not automatically have this same sense of 5. Five is simply a word or a sound that follows four and precedes six in a rhyme. Until children have had extensive rote counting experiences, the word five will have no more meaning than the word *blah* does.

Rational counting helps children develop the sense that there is a one-to-one correspondence between the items in a collection and the words in the sequence.

When young children are asked “How many beans are there?” about the beans in a pile they will often count 1, 2 3 and so on and give an answer – say 8 and when asked: “So how many beans are there?” they will start again counting the beans 1, 2, 3 and so on. These children understand the question “How many?” as an instruction to count out. Only with time and after many repeated rational counting experiences will children reach a point where they understand eight as the number of beans in the pile.

Although some children entering the Foundation Phase in Grade R will have some sense of number – in that they may know some number names and possibly even be able to count a number of objects reliably – the majority entering Grade R (and Grade 1 in the case of those who do not attend Grade R) have a very poor sense of number.

The Foundation Phase teacher must help children first to achieve Level 1 number sense and from there to nurture their development so that the child will reach Level 3 number sense – for at least 2-digit numbers – by the end of Grade 3.



As we support the development of numeracy in the Foundation Phase, the key problems or challenges include the following:

- **Too many children leave the Foundation Phase operating at Level 1**

By the end of the Foundation Phase children should be working at Level 3.

With a poorly developed sense of numbers children are unable to face the challenges of more advanced mathematics.

- **Too few teachers know the level at which each of the children in their class is working.**

It is crucial that a teacher has a very clear sense of the level at which each of her children is working so that she can provide differentiated activities (see below) that are appropriate to the needs of each child.

In part this is the result of **too much whole class teaching** in the Foundation Phase (see classroom organisation Unit 10). By teaching the whole class only, teachers do not get to know the individual children and their needs sufficiently well. This sense is best developed by working with small groups of children on the mat on a regular basis.

- **Too few teachers are making deliberate plans to support the progression of children from one level to the next.**

In the section that follows and in Unit 5 suggestions are made about what it takes to support children in their development.

- **Too many teachers believe that they are helping children by limiting the number range in which they are working.**

It is critical that children are expected to work with as large a range of numbers as possible. It is, in part, through reasoning and engaging with and having to applying larger numbers that children develop a strong sense of number.

If children are not exposed to larger numbers, i.e. the range of numbers with which they are working is limited in Grade 1 to say “less than 10 in the first term” and “less than 20 in the second term” etc. then there is no reason for them to develop a strong sense of number because they can survive using only Level 1 and at most Level 2 strategies.

Guidelines for practice

In this section we deal with classroom activities that can be used to help children develop their **sense of number** moving from one developmental level to the next.

Supporting the development of Level 1 number sense

There are four key interrelated activities that support the development of Level 1 number sense:

- Counting



- ▶ Rote, and
- ▶ Rational
- Representation of numbers through symbols and the interpretation of symbols
- Using numbers in solving problems
- Written work

Counting

Children need to have frequent and extended opportunities to count individually. These opportunities must include both rote and rational counting opportunities.

For those children who come to Grades R and 1 unable to rote count up to at least 20 and 50 respectively, time must be made to rote count **individually** on a regular basis.

The first thing that children need to learn is the names of the numbers and the sequence in which they come (i.e. **social knowledge**).

Rote counting activities

With children who do not know the number words – that is children who have no sense of “the rhyme”, it is important that we start out by teaching them the rhyme.

Activities:

- Saying the number sequence after the teacher (necessary until the children can do so by themselves):
 - ▶ The teacher first counts out the sequence (one, two , three, ... up to 5 and then 10 and then 15 and 20 and so on)
 - ▶ The children repeat the sequence after the teacher – first in the small group sitting on the carpet and then as individuals within this group. As an individual recalls the sequence so the others in the group listen carefully to see if they agree with the individual.
- Learning rhymes that include number names – rhymes that include actions allow the child to become physically involved in the counting activity
 - ▶ There are many rhymes such as:

One, two, buckle my shoe;
 Three, four, open the door;
 Five, six, pickup sticks;
 Seven, eight, lay them straight;
 Nine, ten, a big fat hen;

One potato, two potato
 Three potato, four,
 Five potato, six potato
 Seven potato, MORE!

Although rote counting plays an important role in developing the **social knowledge**



about numbers – i.e. the number names, children who can rote count do not necessarily associate meaning with the words.

In order for the numbers to have meaning for children, they need to engage in **rational counting** activities (see below).

One last comment regarding rote counting:

- While it is tempting to engage the children in whole-class rote counting/chanting activities very few children benefit from this. In general, children hide in the group and the activity is nothing more than a way of keeping the class busy.

Rational counting activities

As children develop their knowledge (**social knowledge**) of the number names so they are ready to start rational counting – the act of counting out physical objects.

Children need a lot of help as they start with rational counting. At first Grade R and Grade 1 children will simply say the number words in sequence as they point to objects at random, they won't necessarily know when to stop counting and may even count some objects more than once.

The teacher's role is to help children to organise the objects that they are counting – this means moving objects from one place to another as they are counted.

It is important that the early counting activities be linked to the development of **social knowledge** in particular, the writing and recognition of number symbols. Having counted a collection of objects children should write down the number symbol of the number they reach and/or point to the number on the number chart.

Different children will be able to count correctly up to different amounts. It is desirable to allow each child to count as far as he/she can. Teachers should avoid deciding on a target for the whole class before the counting activities.

As children gain confidence so the teacher can add rhythm to the counting so that children start to develop a sense of the "patterns" within the numbers. For example: 1, 2, 3, 4, **5**, 6, 7, 8, 9, **10**, 11, 12, 13, 14, **15**, ... by placing emphasis on the multiples of 5 we prepare children for rote counting in fives.

As children gain confidence in their rote counting abilities so the teacher can expand the rote counting activities to include:

- An increasing number range that is, the number "up to which children count" increases as their confidence increases.
- Skip counting – counting first in tens, then in fives and so on, and
- Counting backwards as well as forwards



The activities below all refer to counters – each class should have a very large container of counters. These counters should be easy to handle and should ideally all look the same. Broad beans and bottle tops are ideal.

Activities:

- Each child (on the mat) is given a turn to count a pile of counters.
 - ▶ Place the pile of counters in the middle of the mat and ask: “How many counters are there in this pile?”
 - ▶ Watch as each child counts the counters and ensure that they do so systematically and correctly.
 - ▶ Having counted their pile let them write the number in their books (see classroom organisation).
 - ▶ Keep a record of how far each child can count each day and make sure to give them a slightly larger pile the next time.
- Activities with number cards.
 - ▶ Hand out a set of cards (with dots) to each child and ask the child to arrange the cards from smallest (with the fewest of dots on it) to the largest (with the most of dots on it).
 - ▶ This activity can be extended as follows for children who already have the necessary social knowledge of being able to recognise the number symbols and/or names:
 - Give each child a set of cards with dots and a set of cards with number symbols on them. Ask each child to match the cards (dots and symbols).
 - Give each child a set of cards with dots and a set of cards with number names on them. Ask each child to match the cards (dots and names).
 - Give each child a set of cards with dots, a set of cards with number symbols and a set with number names on them. Ask each child to match the cards (dots, symbols and names).

By encouraging children to count as far as they can as opposed to counting up to a predetermined limit imposed by the teacher, children develop:

- greater confidence at counting smaller amounts;
- a sense of the muchness of numbers: it takes longer to count the larger numbers; and
- an appreciation of the structure of the number system.

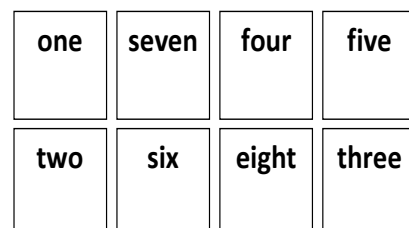
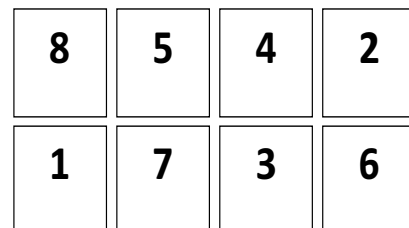
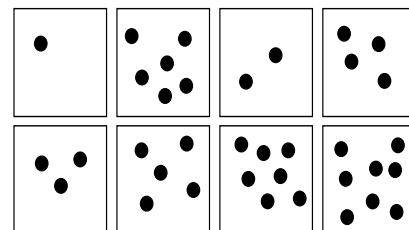

- Each child (on the mat) is asked to count a given number of objects.
 - ▶ Say: "I want you to count out 14 counters"
 - or
 - ▶ Write down a number and say: "I want you to count out (pointing at the number) so many counters"

This activity is very similar to the earlier counting activity but it expects children to be able interpret number words and symbols.

- Estimate the number of counters in a pile and count (this is also suited to Level 2 and 3).

As children are gaining confidence with the basic counting skills described above they will be starting to develop a sense of the muchness of numbers – they are ready to start estimating and checking their estimates.

- ▶ Places a pile of counters on the mat.
- ▶ Ask the children to estimate the number of counters in the pile – they should either write down their estimate or tell it to the group.
- ▶ One of the children is asked to count the pile of counters while the other children listen to see if it is done correctly.
- ▶ Compare the estimates that the children made with the actual number.

At first we should expect that children's estimates will vary widely from the actual amount, but with time and as they develop a sense of the muchness of numbers so they will become more accurate. In comparing their estimates with the actual numbers, the teacher should encourage children to get a sense of whether their estimate was more or less than the actual number and even whose estimate was closest to the actual number – but never "Whose estimate is correct?" as we should not have an expectation that estimates are correct – only better or worse.

Representation of numbers through symbols and the interpretation of symbols

Children need to learn both to write the numbers that they count and to read written numbers.

Activities:

The following activities should be integrated with rote and rational counting activities (see above):

- Letting children point to the numbers on a number board as they **rote count**.

- Letting children count out a pile of objects and then point out the number that they reached on the number board.
- Letting children count out a pile of objects and then write down the number that they reached in their book.
- Showing children a card with a number on it and asking them to say the number name.

Using numbers in solving problems

As much as children at this level of number development should be given the opportunity to count objects (as described above) it is also important that they see some reason for doing so – that is they need to see value in the counting that they are doing. In order to achieve this we can ask children questions related to the counting that they are doing.

Activities:

Children should be given the opportunity to solve problems such as:

- “Here are some counters. I wonder how many each of you will get if we give the same number of counters to each of you.”
 - ▶ Children share out the counters one by one and count their piles.
- “Here is a picture of some birds. How many worms will we need if we are going to give each bird two worms?”
 - ▶ Children place two counters next to each bird and count the total number of counters.
- Having counted out a pile of counters we ask: “How many more counters do you need in order to have a total of 15 counters?” or “How many counters must you give back so that you only have 8 counters?”
 - ▶ Children solve the problem using a method that makes sense to them and explain their thinking.

Written work

As the teacher works with a small group on the mat, the rest of the class need to be working at their tables. It is important that the task set by the teacher reinforces the work being done on the mat.

The activities selected by the teacher should match the developmental stage of the child. In particular, the stage of number development at which the child is.

- For children who are working at Level 1 these written activities consist largely of counting activities and some activities that can support the development of social knowledge (the writing of number symbols etc).



Activities include:

- Counting

How many stars? Write the number in the box.

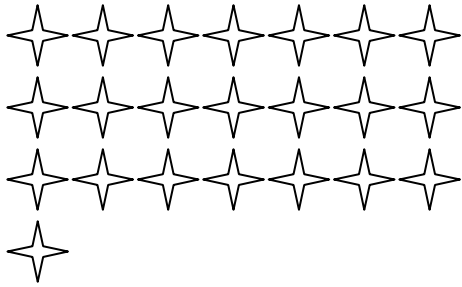
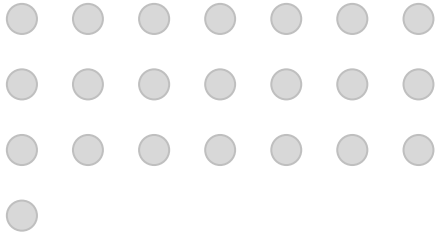
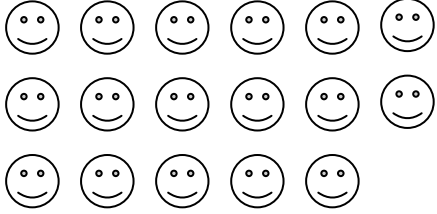
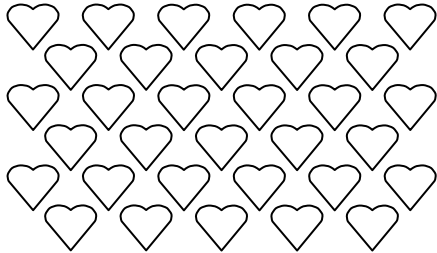
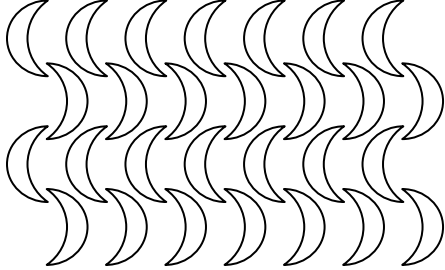

Count	Make the same number	Fill in
		<p>22</p>
		
		
		



- Tracing numbers

Follow the arrows to write over the dotted lines.



Handwriting practice sheet for numbers 7, 4, 8, 5, 2, 9, and 6. Each number is presented on a set of three horizontal lines (top, middle-dotted, bottom). The numbers are shown in a large size with stroke order arrows, followed by a row of smaller dotted versions for tracing, and then a row of blank lines for independent practice.

- 7:** One large example with stroke order arrows, followed by a row of 8 dotted numbers, and a row of blank lines.
- 4:** One large example with stroke order arrows, followed by a row of 8 dotted numbers, and a row of blank lines.
- 8:** One large example with stroke order arrows, followed by a row of blank lines.
- 5:** One large example with stroke order arrows, followed by a row of blank lines.
- 2:** One large example with stroke order arrows, followed by a row of 8 dotted numbers, and a row of blank lines.
- 9:** One large example with stroke order arrows, followed by a row of blank lines.
- 6:** One large example with stroke order arrows, followed by a row of 8 dotted numbers, and a row of blank lines.

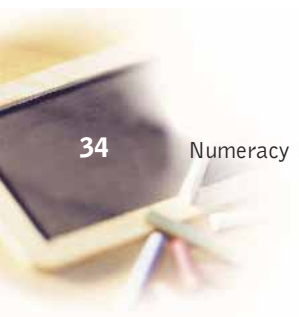

- Joining the dots

The image contains two dot-marker puzzles. The top puzzle is a large rabbit's face and body, composed of 44 numbered dots. The bottom puzzle is a smaller rabbit's eye, composed of 22 numbered dots, with the first dot already connected to the second by a line.



- **Number relationships**

As children are developing their sense of number so they also need to learn how to write down number relationships. They can practice this by completing activities such as those alongside.

Activity

Make the sides equal:

$6 = 5 + \dots$	$7 = 6 + \dots$
$6 = 4 + \dots$	$7 = 5 + \dots$
$6 = 3 + \dots$	$7 = 4 + \dots$
$6 = 2 + \dots$	$7 = 3 + \dots$
$6 = 1 + \dots$	$7 = 2 + \dots$
	$7 = 4 + \dots$

$8 = 5 + \dots$	$5 + 3 = \dots$
$8 = 7 + \dots$	$1 + 7 = \dots$

$\dots + 5 = 6 + 2$
 $3 + 5 = 4 + \dots$
 $5 + \dots = 7 + 1$

Supporting the development of Level 2 and Level 3 number sense

After reaching Level 1 in terms of their number development children need to be supported in moving to Levels 2 and 3.

Level 2 represents a transition phase between Level 1 and Level 3 and for that reason the activities described below make no distinction between activities for each of these levels.

Children are unlikely to progress beyond Level 1 unless there is a reason for them to do so – and one very good reason for doing so is to cope with the larger numbers.

There are four key interrelated activities that support the development of Level 3 number sense:

- Counting
 - ▶ Rational counting only – there is no need to spend time on rote counting with children who have reached Level 1 and beyond.
- Breaking down and building up numbers
 - ▶ Flard cards
 - ▶ “Up and down the number line”
- Using numbers in solving problems
- Written activities



Counting

As children develop from Level 1 to Levels 2 and 3 they still need to engage in a lot of rational counting activities. The nature of the activities however changes from those described earlier to activities that focus on:

- counting larger quantities in efficient ways including the use of grouping; and
- counting on from a given point.

The activities described below should take place in the context of children (in small groups) working with the teacher while sitting on the mat (see remarks in Unit 6 page number 101 and Unit 10).

Activities:

- **Counting using counting frames**

Counting using counting frames can help children both with their ability to count in 10s and also to learn how to complete tens and count on.

For example if asked to count out 73 on a counting frame we would expect children to develop the confidence to count: 10, 20, 30, 40, 50, 60, 70, 71, 72, 73 and when asked how many more beads are needed to reach 80, the child will count on and see that 7 more are needed.

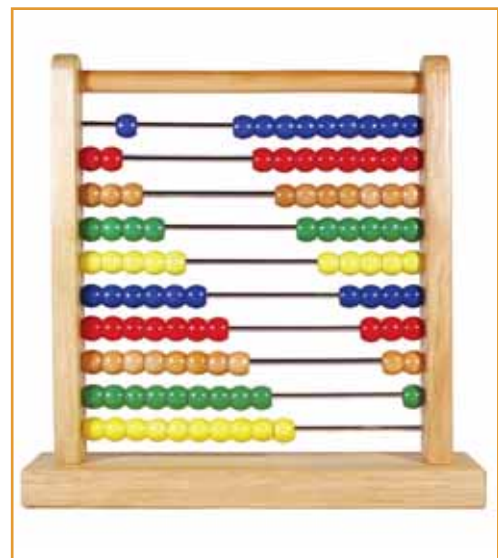

- **Counting body parts – as an introduction to skip counting**

While sitting with a small group on the mat:

- Ask: "How many children are there in the group?" and let one of the children walk around the group touching each member and counting aloud: one, two, three,
- Ask: "How many eyes are there in the group?" and let one of the children walk around the group touching each member's eyes, counting aloud: one, two, three, ...
- Ask: "Could we have counted the eyes more quickly?" and let one of the children walk around the group touching each member's pair of eyes, counting aloud: two, four six, ...
- Repeat the above activities for:
 - ▶ Ears;
 - ▶ Hands and fingers (counting first in fives and then in tens); and
 - ▶ Feet and toes (counting first in fives and then in tens).

- **Counting as far as possible**

Provide a very large pile of counters and let the children on the mat count the counters in the pile by taking turns.

Let one child start the counting and ask the next child to take over when the first child reaches a number inside a decade (e.g. 37 or 83 etc). The pile should contain several hundreds of counters so that each child, in their turn, counts through at least two or three decade transitions.

It is important to count well beyond one hundred in this way as many children will only develop their sense of two-digit numbers when working with three-digit numbers.

As the numbers get larger the children should be helped to group the objects in sensible groups (twos, fives, tens etc).

- **Counting on**

A variation of the *counting as far as possible* activity is to have the children count the counters into a container (say a jar) and to write the number reached on any one day on the side of the jar. On the next day the group continues to add counters to the jar and the new total is written on the side. Continue in this way and see how far each group on the mat can get each week.

- **Grouping and counting**

Give each child 20 counters and ask each child to arrange his/her counters in groups – (two's or fives or tens or whatever they want)

The children count all the counters (as a group) in the groups as they are arranged. (The teacher will have to make a decision about the order in which the counters are going to be counted. It is unrealistic to expect them to count large numbers in e.g. 4's or 6's.)

- **Estimating the number of counters in a pile and counting**

This is exactly the same activity as the one mentioned for Level 1 (page No. 26), however this time the pile of counters is much larger and children working in a group, on the mat, work together to arrange the counters in sensible piles (5s, 10s, 50s and 100s) and in so doing to determine the number of counters in the pile.

- **Throwing dice and adding the numbers**

The children take turns to throw two or three dice and to add the numbers together as quickly as possible.

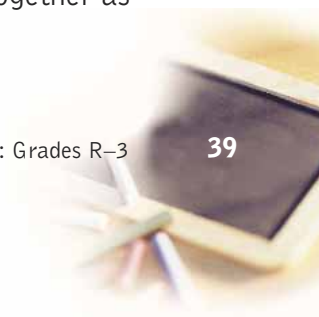

- “Is it fair or unfair”

The game “is it fair or unfair” can also be used to help children develop the skill of breaking down and building up numbers. The game is easily played with the teacher asking question such as:

- ▶ Conrad says to Susan: “If you help me, I will give you half of my money.”
Conrad has R1. He gives 40 cents to Susan.
Is this fair? Why?
- ▶ Rashida says to Faisal: “I will give you half of my money if you help me.”
Rashida has R6. She gives R3 to Faisal.
Is this fair? Why?
- ▶ Vuyani says to Sikelele: “I will give you half of my sweets if you help me.”
Vuyani has 18 sweets.
How many sweets must Vuyani give to Sikelele to be fair?
- ▶ William says to Sam: “I will give you half of my sweets if you help me.”
William has 22 sweets. He gives 10 sweets to Sam.
Is this fair? Why?

Breaking down and building up numbers

Level 3 number sense involves children being able to do three related actions:

- Breaking down (decomposing) numbers;
 - Reorganising the parts; and
 - Recombining them
- to perform a calculation and/or to solve a problem.

$$\begin{array}{l} 60 + 20 = 80 \\ 6 + 8 = 14 \\ 14 - 10 = 4 \\ 80 + 10 = 90 \\ 90 + 4 = 94 \end{array}$$

This Grade 2 child is solving a problem which involves determining the value $66 + 28$. She breaks the numbers into $60 + 6$ and $20 + 8$ and then uses her knowledge of combinations of single-digit numbers ($8 + 5 = 13$) and combinations of multiples of ten ($60 + 20 = 80$) as tools for determining 66 as her answer.

The image shows a student's handwritten work on lined paper. At the top, the number 134 is decomposed into three parts: 100, 40, and 3. Each part is written inside a circle. To the right of these circles, the number 134 is written twice, with arrows pointing from the circles to the corresponding digits. Below this, the equation $400 + 100 + 60 + 12 = 572$ is written. Arrows point from the 400, 100, 60, and 12 terms to the final result 572. The 572 is written with a checkmark next to it.

This Grade 3 child is solving a problem that involves the repeated addition of four lots of 134.

First the child **decomposes** 134 into 100 and 40 and 3.

She then **reorganises** the parts to **combine** the four 100s to get 400, the four 40s to get 160 and the four 3s to get 12.

Then she **decomposes** the 160 into 100 and 60, **reorganises** and **combines** the 400 and the 100; and the 60 and the 12. Finally she **combines** 500 and 72 to give an answer of 572.

In order to assist children in developing a sense of all the ways in which they can **break down**, **reorganise** and **build up** numbers teachers need to provide opportunities that help them to think about various ways of doing so.

Activities:

- **Cards with pictures on them**

Given cards such as those on the right, children are asked first to count each group of objects and then to count the total. Variations include having children make their own arrangements of pairs of numbers for example:

- ▶ Make as many pairs of numbers that together make 5, 10, 15, 20 and so on.
- ▶ Make the number 12 using two numbers, using three numbers, using four numbers and so on.
- ▶ For a given set of cards determine how many more dots are needed to make 10, 20, 30 and so on.

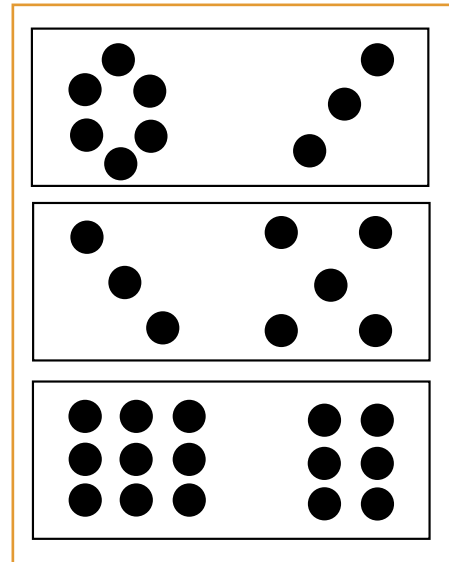

These questions and more like them will help children to develop a sense of all of the different ways in which different numbers can be made.

- **The use of Flard cards**

Flard cards (see printable master in Appendix B) are cards that allow children to build up numbers from their constituent hundred, ten and unit elements.

Foundation Phase children who are working with a number sense at or below Level 3 are not able to think of 758 as $7H + 5T + 8U$ because this is too abstract for them. By contrast these same children can work with the idea of "seven hundred plus fifty plus eight" much more easily because this way of thinking matches the way in which they read and say the number names more closely.

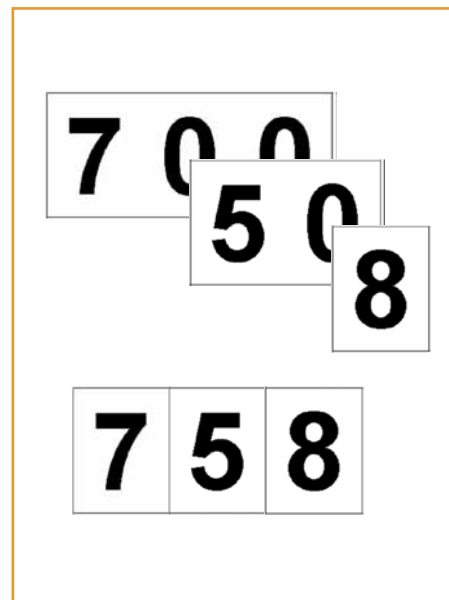

- Give each child on the mat a set of Flard cards. The first thing that they must do is to pack out the cards in sequence – it helps to have the children pack out the card as this allows them to focus on the tasks that follow instead of them searching for the different cards. NOTE: For Grade 1s who it may be advisable to start out with only the tens and units in a pack.
- Having counted to, say, 247 earlier in the session on the mat, the teacher asks the children to make 247 using their Flard cards. Once the children have made 247 the teacher asks them which cards they used – by sliding the cards apart they come to realise that: $247 = 200 + 40 + 7$.
- The teacher writes down or says a number and asks the children to make the number with the Flard cards. Each time the children have done so the teacher helps them unpack the number and is so doing to “break up” the number into a certain number of hundreds, tens and units.
- For children who are more confident with using the Flard cards the teacher can pose questions such as:
 - ▶ Make 385 in at least two different ways using the Flard cards. Possible solutions include: $300 + 80 + 5$; and $200 + 100 + 60 + 20 + 1 + 4$.
 - ▶ Make 653 in at least three different ways using the Flard cards. Possible solutions include: $600 + 50 + 3$; $400 + 200 + 20 + 30 + 1 + 2$; and $500 + 60 + 80 + 6 + 7$.

The first time that children use the Flard cards to make 247 they are likely to take the numbers 2, 4 and 7 and place them next to each other. Rather than telling the children what to do it is recommended that the teacher says – “what you have here is 2 and 4 and 7, does 2 and 4 and 7 make two-hundred and forty seven?” This will cause the child to reflect and after some thinking most children will realise that two-hundred and forty seven is *made up* of 200 and 40 and 7.

NOTE: there is no expectation in the last of the activities listed above that the cards can be placed on top of each other to reveal the number being constructed. What these latter activities do is to force the child to explore number relationships/bonds and in particular the combinations of numbers that can be used to make other numbers. $150 = 100 + 50$ and $150 = 70 + 80$ etc.

- **“Up and Down the Number Line”**

Being able to **break down, reorganise** and **build up** numbers requires that children have a well developed mental number line. This mental image allows children to sequence numbers and to move flexibly between them.

To assist children to develop this number line and to move flexibly along it the teacher can, while working with children

T: I have 27, what do I need to get to 30?
 C: 3
 T: Good, now what will I have left if I give away 8?
 C: 22
 T: Great, and what must I give away so that I am left with 15?
 C: 7
 T: Fine, and what will I get by adding another 20?
 C: 35
 T: Correct, how many more do I need to get to 40?
 C: 5
 T: What will I get when I ...

on the mat (see classroom organisation), have children participate in a sequence of questions and answers such as the one in the box alongside.

“Up and down the number line” is an activity that should be completed mentally – if children are doing the calculations on their fingers then they are probably still at Level 1 and in need of some of the less sophisticated activities mentioned above or the same activity but with smaller numbers at each stage.

With children who are in the early stages of achieving level 2 number sense, the numbers used in the activity will be very small (1s, 2s and 3s). As the children’s confidence grows so the activity can be used to develop skills used by people with a strong sense of number. Such skills include:

- Completing tens
 - ▶ I have 17, what do I get if I add 3?
 - ▶ What must I add to 27 to get 30?
- Bridging tens
 - ▶ I have 17, what do I get if I add 8?
The expectation is that the child will first complete the ten and then add on the remainder. Their thinking could be summarised as: *“I have 17, I need 3 to make 20, $8 - 3 = 5$ so the answer is $20 + 5 = 25$.”*
 - ▶ What must I add to 27 to get 32?
- Adding to multiples of ten
 - ▶ I have 17, what will I get if I add 33?
 - ▶ What must I add to 27 to get 60?
- Adding and subtracting multiples of ten
Children need to realise that if $2 + 3 = 5$ then $20 + 30 = 50$ and $200 + 300 = 500$
 - ▶ I have 30, what will I get if I add 50?
 - ▶ I have 70, what will I get if I take away 30?
 - ▶ What must I add to 10 to get 70?
 - ▶ What must I take away from 90 to be left with 30?
- Subtracting to multiples of ten
 - ▶ I have 27, what do I get if I take away 7?
 - ▶ What must I take from 45 to get 40?
- Subtracting from multiples of ten
 - ▶ I have 70 what do I get when I take away 8?
 - ▶ What must I take away from 40 to get 36?

As children gain confidence in completing this activity within a two-digit number range so teachers can extend exactly the same activity to numbers within the three-digit range. That said, it is not likely that this will happen before Grade 3 at the earliest.

Using numbers in solving problems

The use of meaningful problems is one of the three crucial factors for developing Numeracy identified in Unit 2. The role of meaningful problems is discussed in detail in Unit 4 – please read this.



In terms of classroom management children should be exposed to problems on a frequent basis as they work with the teacher on the mat. They should be given the opportunity to solve the problems, to explain their solution methods and to listen to and learn from the solution methods of the other children in the group on the mat.

While working on problems on the mat children should:

- Have a book in which to record their thinking and solutions strategies.
- Have access to tools that may help them in solving problems such as:
 - ▶ Counters;
 - ▶ Counting frames;
 - ▶ Flard cards; and
 - ▶ Numbers lines.

It would seem as if the 100 board is not so useful in helping children to develop problem solving skills and number sense – the board does not really help children to develop a sense of the relative sizes of numbers.

While these tools may help, they are no more than aids and with time as the child's number sense get stronger we would expect children to become less reliant on them.

While working on problems on the mat teachers should:

- Have a notebook in which to record their observations about the children in each group, in particular:
 - ▶ The number level at which each child is working; and
 - ▶ The types of problem solving strategies that they are using.
- Have a list of problems that they plan to work through – the success of using problems to develop both computational strategies and a strong number sense lies in the kinds of problems used by the teacher – random problems “invented” on the spur of the moment will not have the desired effect. See the discussion of appropriate problem types in both Units 4 and 5.

Written activities

As the teacher works with a small group on the mat, the rest of the class need to be working at their tables. It is important that the task set by the teacher reinforces the work being done on the mat.

The activities selected by the teacher should match the developmental stage of the child. In particular, the stage of number development at which the child is.

- For children who are working at Levels 2 and 3 these written activities focus on the **breaking down, reorganising** and **building up of numbers**.



Activities include:

- **Counting**

The counting activities used with children who have achieved Level 1 number sense and who we are trying to encourage to move toward Levels 2 and 3 should invoke the child to break down and build up numbers. This involves counting on, counting in groups and breaking the collection of items to be counted into smaller collections that are more easily counted.

The kinds of counting activities used at this stage in a child's number level development (Level 2 and Level 3) include:

- ▶ Counting grouped objects: grouped objects encourage children to learn to count in groups (to skip count).
- ▶ Counting objects arranged in grids: objects arranged in grids encourage children to skip count and also to construct their conceptual knowledge of the commutativity.
- ▶ Counting items where part of the collection of items is hidden.
- ▶ Counting collections of objects that can be quite naturally broken up into smaller collections that can be counted more easily.

An example of grouped objects.

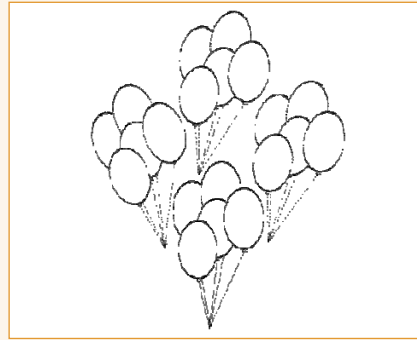

An example of objects arranged in a grid.

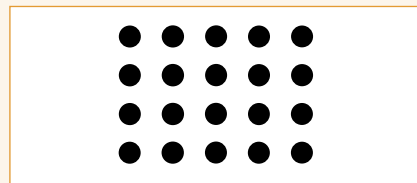

By counting the dots in the grid above children will come to realise that the number of dots can just as well be through of as $4 + 4 + 4 + 4 + 4$ or as $5 + 5 + 5 + 5$.

This observation leads to the realisation that $4 \times 5 = 5 \times 4$.

When children realise that $4 \times 5 = 5 \times 4$ they will have not only learnt an important pattern, but they will also have halved the number of number facts that they need to remember.

An example of a collection to be counted where part of the collection is hidden.



An example of a collection to be counted where part of the collection is hidden In order to count the number of small squares in this bar of chocolate, the child is left with no option but to count in multiples of 5 or 7 since they cannot actually count each and every square in the bar of chocolate.

Activity

How many beads? Write the number in the box:



Activity

How many apples? Write the number in the box:

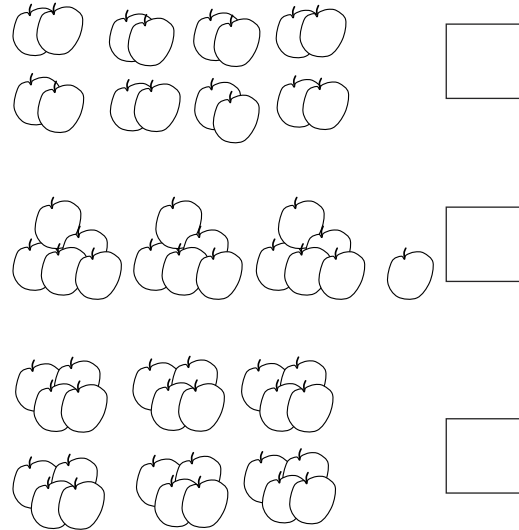

Activity

How many dots? Write the number in the box:

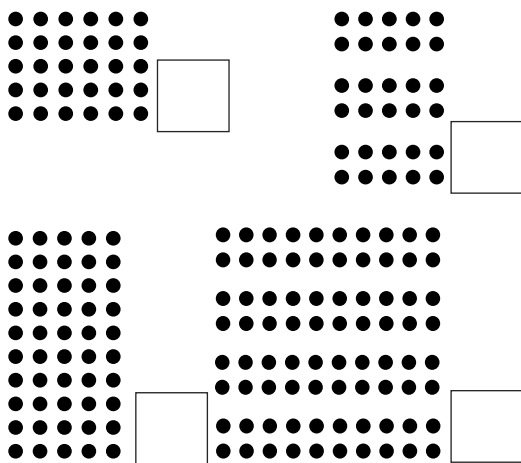

Activity

How many small blocks? Write the number in the box:

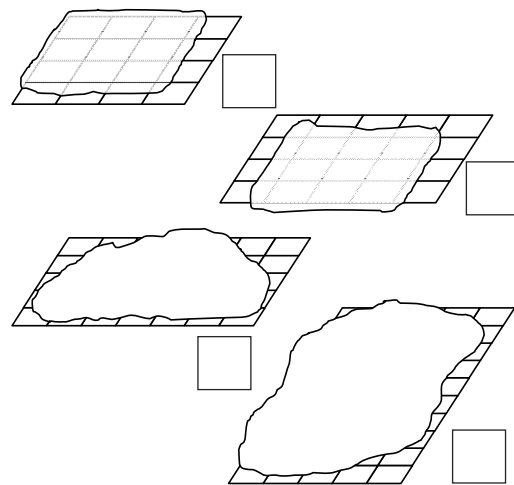

- **Completing number patterns**

In order for children to develop a sense of the regularity and patterns within numbers they should be able to extend number patterns. This of course requires that they can recognise the pattern within the elements of the pattern supplied.

Complete the following:

5	10	15
27	30	33
...	...	28	34	40

There are two key kinds of written activities involving patterns that can help in the development of number sense at this level.

- ▶ The first (illustrated top box alongside) is a sequence of numbers with some of the terms of the pattern given and the child must complete the pattern by either extending the pattern by a number of terms or filling in some missing terms – this kind of pattern is useful in developing skip counting and adding-on type skills.
- ▶ The second kind of pattern recognition task (illustrated in the in the other two boxes alongside) requires children to complete a series of simple arithmetic operations. In completing the calculations posed the child should also notice a pattern.

Complete the following:

$5 = 1 + \dots$	$50 = 10 + \dots$
$5 = 2 + \dots$	$50 = 20 + \dots$
$5 = 3 + \dots$	$50 = 30 + \dots$
$5 = 4 + \dots$	$50 = 40 + \dots$

Complete the following:

$5 = 1 + \dots$	$5 - 1 = \dots$	$\dots + 1 = 5$
$5 = 2 + \dots$	$5 - 2 = \dots$	$\dots + 2 = 5$
$5 = 3 + \dots$	$5 - 3 = \dots$	$\dots + 3 = 5$
$5 = 4 + \dots$	$5 - 4 = \dots$	$\dots + 4 = 5$

It is the recognition of the patterns within and between situations that help children in the development of logico-mathematical (conceptual) knowledge – something that is crucial in the development of a robust number sense. However, it should be noted that the child is more likely to notice the pattern only if the teacher asks them to reflect on the activity – once again highlighting the importance of discussion.

Teachers can create many such examples using numbers that are appropriate to the number range within which her class is working.

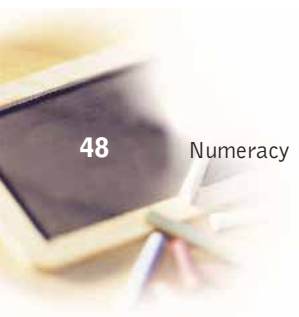

Activity

These are number patterns. Can you complete them?

2; 4; 6;;;;;;;

5; 10; 15;;;;;;;

10; 20; 30;;;;;;;

5; 7; 9; 11;;;;;;;

.....;;; 17;; 27;; 37;;

.....;;; 30;; 20;; 10;;

.....; 16;; 24;; 32;;;;

.....;; 90; 84;;; 66;;;

Activity

Make the sides equal:

$$11 = 1 + \dots \quad 15 - \dots = 9$$

$$11 = 2 + \dots \quad 15 - \dots = 10$$

$$11 = 3 + \dots \quad 15 - \dots = 11$$

$$11 = 4 + \dots \quad 15 - \dots = 12$$

$$11 = 5 + \dots \quad 15 - \dots = 13$$

$$11 = 6 + \dots \quad 15 - \dots = 15$$

$$27 + \dots = 31 \quad 23 = \dots + 6$$

$$37 + \dots = 41 \quad 33 = \dots + 6$$

$$47 + \dots = 51 \quad 43 = \dots + 6$$

Activity

Make the sides equal:

$$4 = 2 \times \dots \quad 2 \times \dots = 36$$

$$6 = 2 \times \dots \quad 3 \times \dots = 36$$

$$8 = 2 \times \dots \quad 6 \times \dots = 36$$

$$10 = 2 \times \dots \quad 12 \times \dots = 36$$

$$12 = 2 \times \dots \quad 18 \times \dots = 36$$

$$14 = 2 \times \dots$$

$$12 \div \dots = 2 \quad 3 = \dots \div 6$$

$$10 \div \dots = 2 \quad 4 = \dots + 6$$

$$8 \div \dots = 2 \quad 5 = \dots + 6$$

Activity

Make the sides equal:

$$10 = 2 \times \dots \quad 3 \times \dots = 18$$

$$10 = 2 + \dots \quad 3 + \dots = 18$$

$$10 = \dots - 2 \quad \dots - 3 = 18$$

$$10 = \dots \div 2 \quad \dots \div 3 = 18$$

$$\dots = 10 \times 5 \quad 12 \times 6 = \dots$$

$$\dots = 10 + 5 \quad 6 \times 12 = \dots$$

$$\dots = 10 - 2 \quad 12 \div 6 = \dots$$

$$\dots = 10 \div 2 \quad 6 \div 12 = \dots$$



- **Tables**

Tables provide a different way in which to represent patterns. The significance of tables lies in the relationship between two numbers that is evident – another pattern that we want children to realise.

Activity

Complete the following tables:

Children	1	2	3	4	5		10	15	24	
Eyes	2	4								64

Cars	1	2	3	4	5		10	15	24	
Tyres	4	8								172

Activity

Complete the following tables:

Ice creams	1	2	3	4	5	6	7	8	9	10
Cost (Rand)	11	22	33							

Ice creams	10	20	30	40	50	60	70	80	90	100
Cost (Rand)	110	220	330							

Ice creams	18	47	53	65	125	163				
Cost (Rand)							352	979		



• **Flow diagrams**

Flow diagrams provide another way of engaging children in productive thinking about numbers and the patterns within numbers.

The flow diagram alongside helps children to recognise that “adding 6 to any number ending in 4 will complete the decade”.

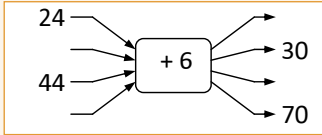
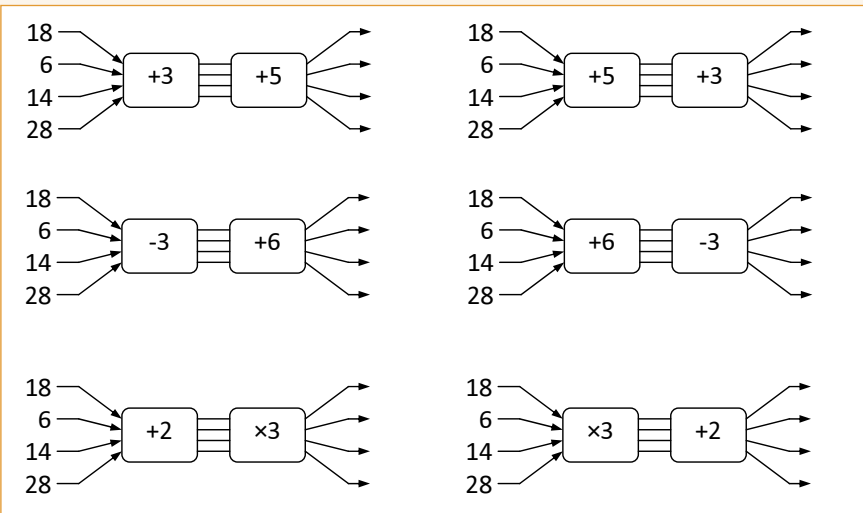



These flow diagrams taken together draw the child’s attention to the fact that when adding and subtracting it does not seem to matter which operation is performed first. However, when multiplying and adding then the order in which the operations are performed does seem to matter.

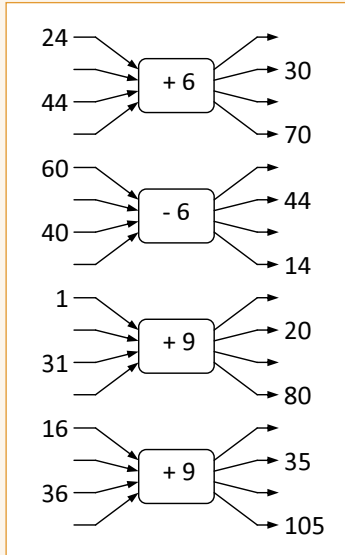

Activity

Complete each of the following flow diagrams.



Activity

Complete each of the following flow diagrams.

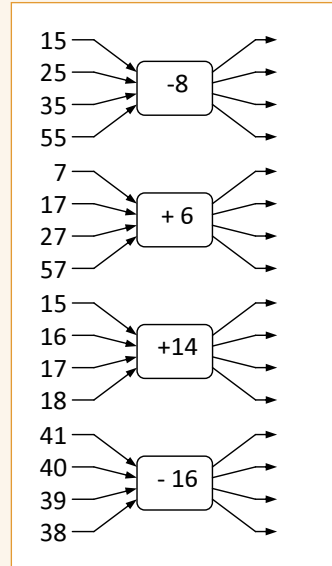

Activity

Complete each of the following flow diagrams.

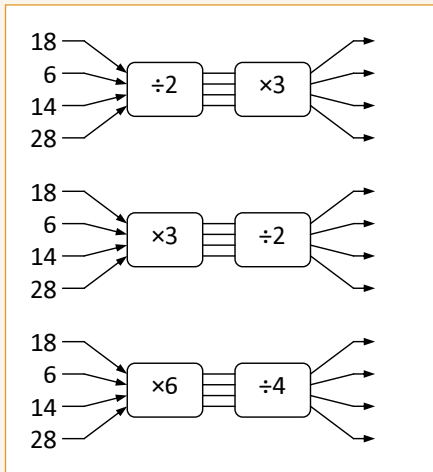

What do you notice?

Activity

Complete each of the following flow diagrams.

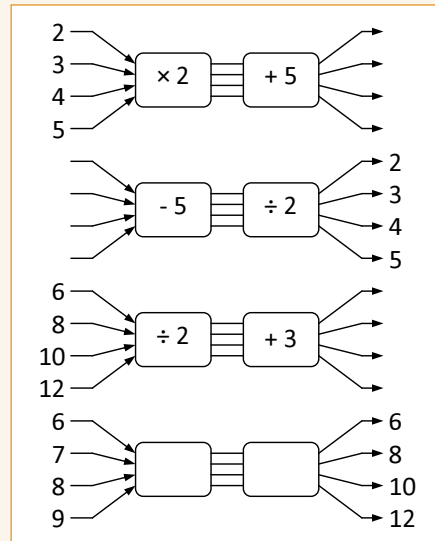

What do you notice?

• **Pyramids**

Pyramids provide another constructive activity for developing number sense.

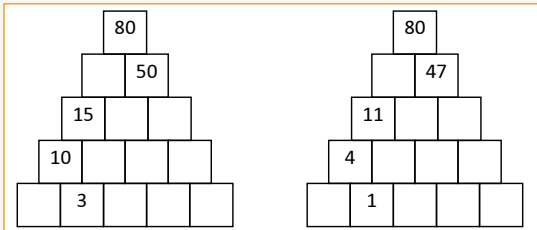

In contrast to the more typical pyramid, shown on the right, pyramids like these force children to break down numbers and think about number combinations.

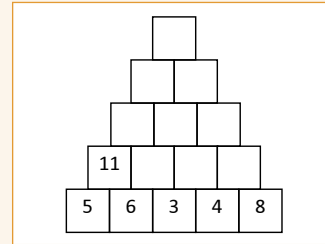

In a typical pyramid the number in each cell is determined by adding together the numbers in the two cells below the cell.

This pyramid provides an opportunity for children to work with numbers and in so doing to develop their number sense.

Activity

Complete each of the following pyramids.

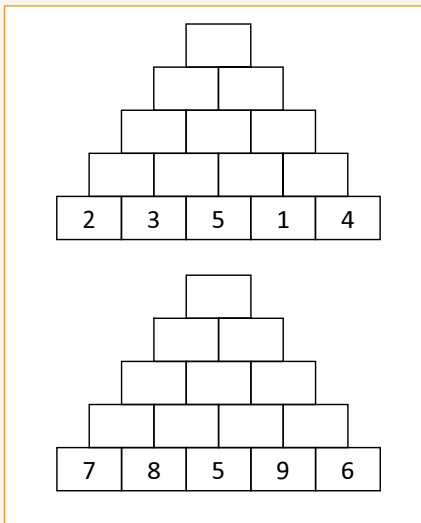

Activity

Complete each of the following pyramids.

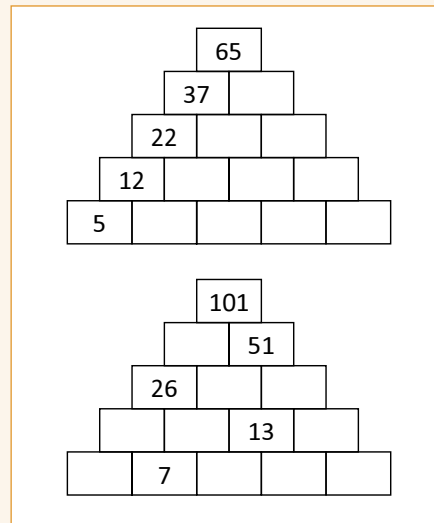

• **Number chains**

Number chains are the written equivalent of the *up and down the number line* activities described earlier.

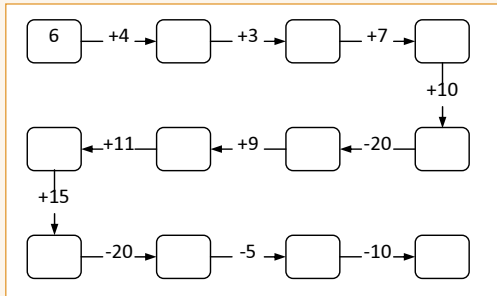

This number chain aims to develop the different skills listed under *up and down the number line* earlier.

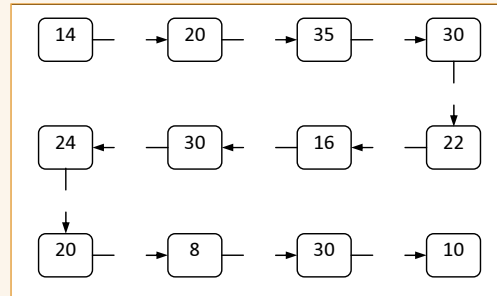

This number chain forces the child to think about the operations required to achieve a particular "target".

Activity

Complete each of the number chains

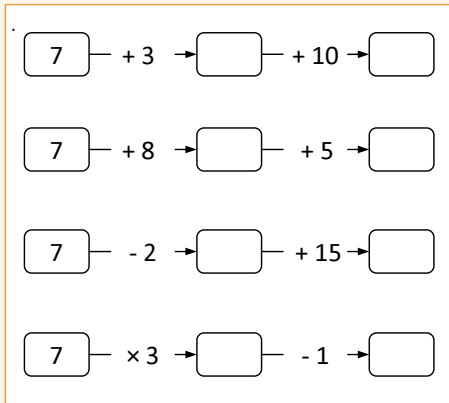

Activity

Complete each of the number chains

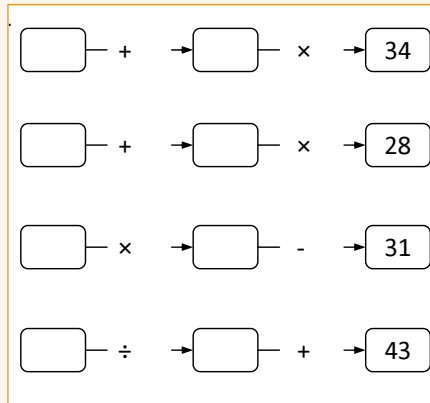

Activity

Complete the following number chain.

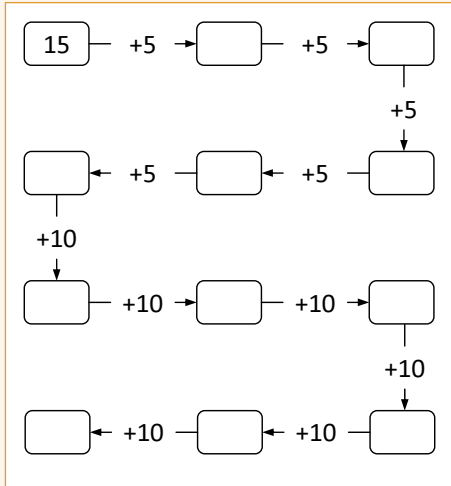

Activity

Complete the following number chain.

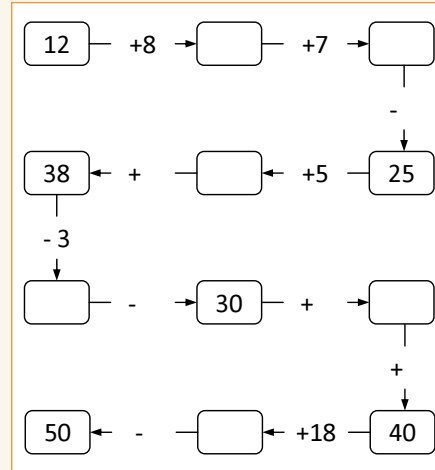

- Problems**

In addition to children solving problems on the mat with the teacher they also need practice in doing so individually and as such should be challenged to solve problems as part of their written work activities as well.

See the discussion on the different kinds of problems that we want children to be exposed to as well as the kinds of engagement that we would like to see them demonstrate in Unit 4.

- Drill and practice**

Being able to operate at Level 3 or higher in terms of number sense requires that each child simply knows a range of number facts.

For this reason there is much to be said for children also being set large collections of exercises involving the four basic operations and numbers appropriate to their stage of development.

$3 + \dots = 10$	$18 - \dots = 10$	$3 \times \dots = 12$	$16 \div \dots = 4$
$41 = 23 + \dots$	$7 = 18 - \dots$	$30 = 5 \times \dots$	$9 = \dots \div 2$
$\dots + 16 = 43$	$\dots - 5 = 17$	$\dots \times 7 = 21$	$\dots \div 4 = 11$

Numbers sentences should be posed in the form illustrated above and children should be encouraged to complete these kinds of exercises against the clock.





Introduction

On the one hand we study mathematics so that we can use it as a tool to solve problems; on the other hand we learn mathematics by solving problems.

Problems are central to mathematics – to solve problems using mathematics requires the development of mathematical knowledge and skills and even mathematics itself. However, in order for young children to develop their mathematical knowledge and skills they must solve problems.

Problems are both the reason for developing mathematical knowledge and skills as well as a vehicle for doing so.

There are three key reasons for using problems as a vehicle for developing mathematical knowledge and skills:

- Problems can be used to introduce children to the so-called basic operations;
- Problems contribute to the development of computational methods; and
- Problems make the mathematical experiences of the child meaningful and relevant.

The role of problems in introducing children to the so-called basic operations

In a particular Grade 2 class children were given the problem alongside: *The tuckshop has made 27 amagwinya (vetkoek). There are 43 children in the class. Are there enough amagwinya for each child to get one?* After some class discussion it was agreed that there were not enough *amagwinya* and the teacher asked the children to determine how many more were needed.

Odwa solved the problem by first drawing 27 stripes to represent the 27 children in the class and then he drew a large number of extra stripes. He counted on from 27: 28, 29, 30 ... 43 and highlighted the 43rd stripe. Finally he counted how many extra *amagwinya* (stripes) were needed and concluded that 16 more *amagwinya* needed to be made. We can summarise Odwa's method as follows: $27 + \boxed{16} = 43$.

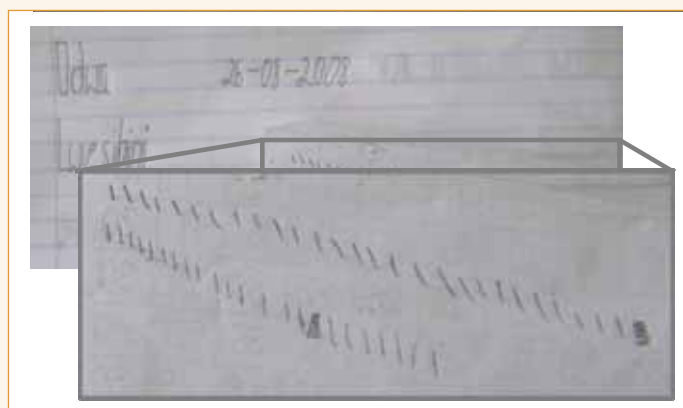
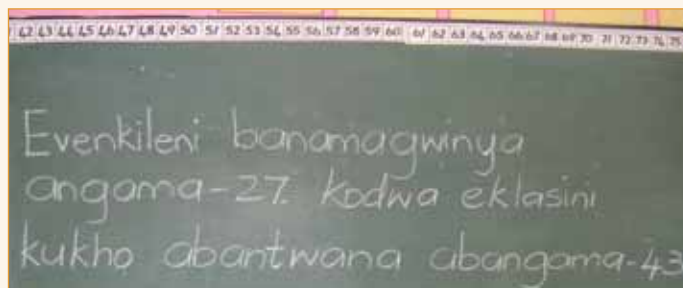



Asavelo solved the problem by first counting out 43 counters. Next she counted out 27 from the 43 – as if she was giving *amagwinya* to those who she could give to. Finally she counted the remaining counters and established that she still needed 16 *amagwinya* for the remaining children. We can summarise Asavelo’s method as follows: $43 - 27 = \boxed{16}$.

Note: Although the numbers in the question are appropriate to Grade 2, the methods used by Odwa and Asavelo clearly reflect that they are working with a Level 1 sense of number. Because Odwa and Asavelo are at Level 1, the numbers used by the teacher in the problem could possibly have been smaller.

The *amagwinya* example illustrates illustrates a number of important ideas about the role of problems:

- Children can solve problems without knowing the words addition or subtraction or for that matter before they know the symbols representing these operations.
- The *amagwinya* problem is not necessarily an addition or a subtraction problem but rather a problem that can be solved using both an addition and a subtraction approach.
- When children are asked to solve problems by making sense of the situations as in the case of Odwa and Asavelo they develop a sense of what it is to add, to subtract, to multiply and to divide from the problem rather than being told the meaning of these operations by their teacher – **they are developing their conceptual knowledge.**

With time the teacher will teach the class that “Odwa’s method” is more generally referred to as addition and summarised using a particular notation while “Asavelo’s method” is referred to as subtraction and is summarised using a different notation.

When the teacher introduces the names and the symbols for the operations she is introducing the children to the **social knowledge** which is commonly used to describe the perfectly natural actions of the children.

The role of problems in the development of computational methods



Sandla, a Grade 1 boy, is solving the problem: *If 17 marbles are shared among 4 children, how many marbles will each child get?* In his first attempt at drawing the situation and solving the problem he draws the four children and the 17 marbles and then he shares the marbles: “one for you, and one for you, and one for you and ...”. He continued in this manner for a few minutes but soon realised that this was becoming quite messy and so he cleaned his board and started again. This time he drew the four children and, allocating one marble to each child at a time, counted out the 17 marbles; one, two, three... until he gave the fourth child the 16th marble and had one left over.

The illustration of Sandla’s work makes the point that because of the size of the numbers involved in the problem his first approach becomes quite messy and Sandla, of his own initiative, decides to approach the problem in a more efficient manner.

In the case of the Grade 3 problems (that appear on page 60) solved by Marie and Susan it should be noted that the problem does not actually ask how much each child will get but rather how the children in the problem should share the money – the focus of the question is not on the answer but on the strategy to be used in solving the problem.

In looking at Marie’s solution we might, on the one hand, argue that the drawing of all of the Rands is a primitive approach for a Grade 3 child, on the other hand, there is clear evidence in her work that Marie is trying to become more efficient – after all she allocates the Rands in groups rather than doing so one at a time.

Taken together the four solutions (Sandla’s two, Marie’s and Susan’s) to two problems with similar structures illustrate how problems can induce children to become more efficient in their computational approaches. See remarks on the teacher’s role in facilitating this increased sophistication in the *guidelines for practice* on the next page.

A Grade 3 class is solving the problem: *Belinda, Rashida, Vuyani and Conrad help Mr Botha in his vegetable garden on a Saturday morning. The children all work just as long as each other. Mr Botha gives them R72 altogether. How must the children share evenly between them?*

In solving the problem Marie drew the 72 Rands and the four children. Careful analysis of Marie's work shows that she starts out by giving each child R10 (notice how the first four rows of Rands are crossed out in lots of 10), realising that she does not have enough Rands left over to give each child another R10, she "halves" the number that she is giving to each child and so gives them R5 each, next she again "halves" and gives each child R2 and finally is left with R4 and gives each child one last Rand. She concludes that each child will get R18.

By contrast Susan solved the problem by drawing four faces representing the four children in the story. She started out by giving each child R20 – realising that she had given away more money than had in total she erased the R20 per person and tried

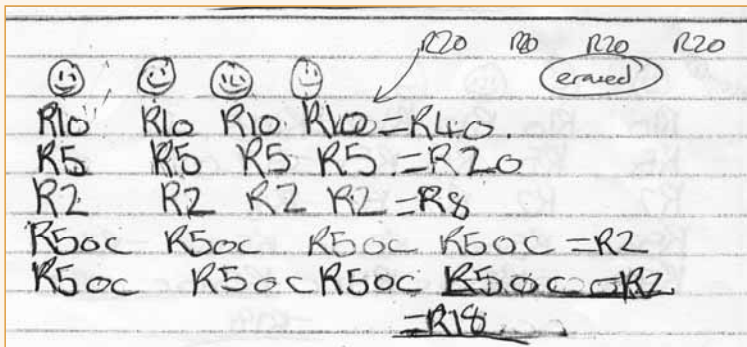
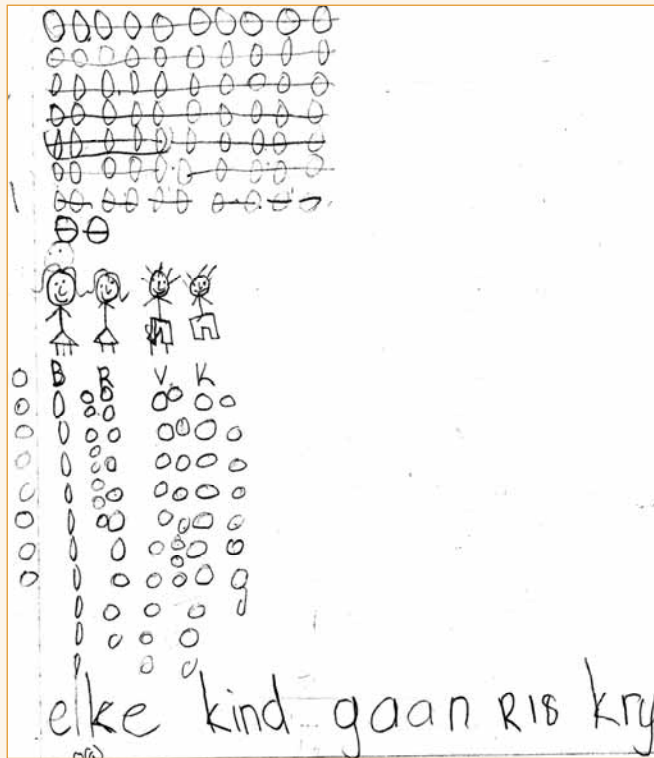

instead R10 each. Next she "halved" and gave each child R5 and continues in this way until she had used up all R72 and also concluded that each child would get R18.

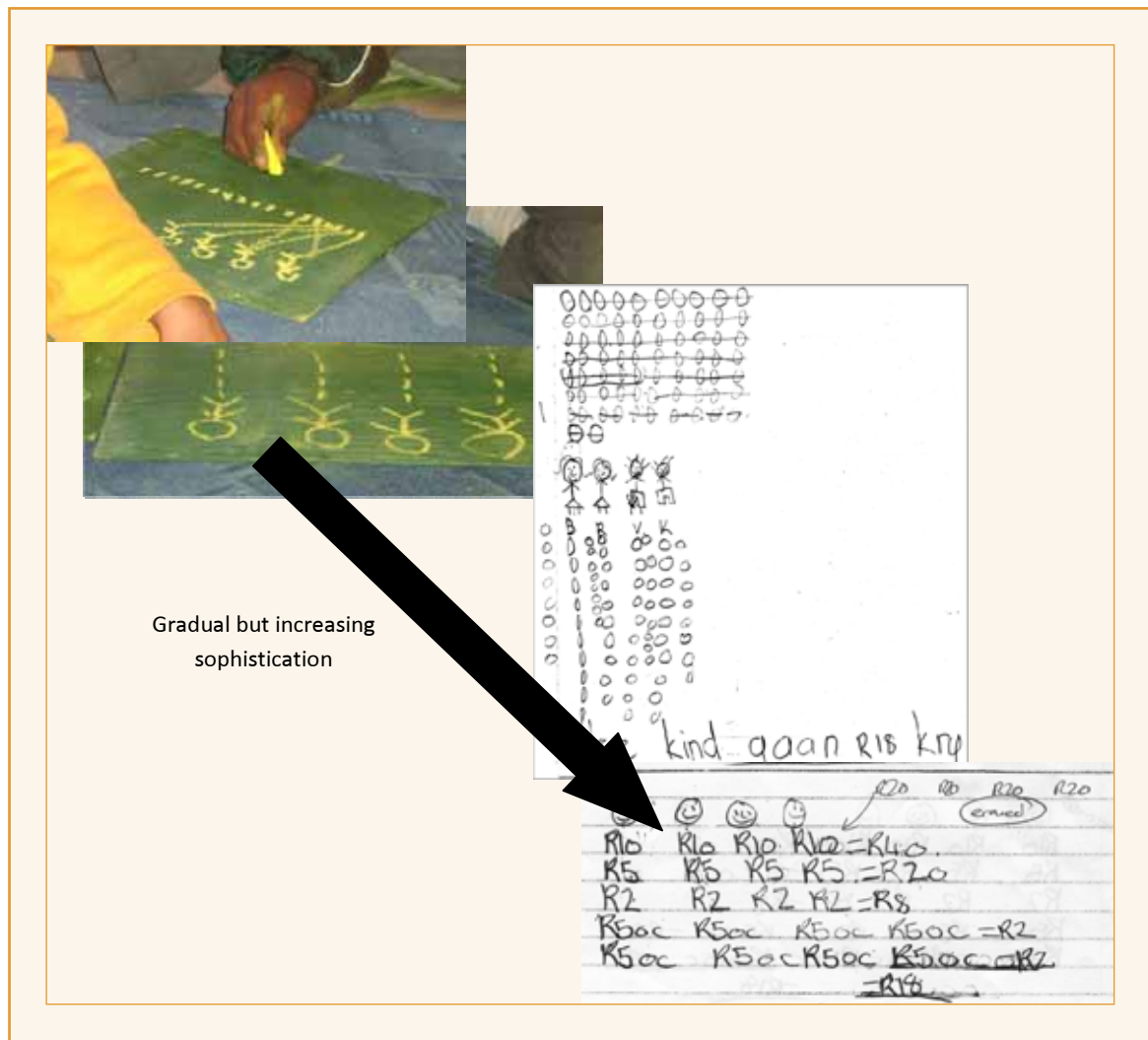

Problems, through their structure, induce children to develop stronger computational approaches and at the same time to develop a deeper sense of what it means to add, subtract, multiply and divide.

Consider the three problems below:

- Arun has 17 marbles and loses 11. How many marbles does he have left?
- Arun has 17 marbles and Benni has 11 marbles. How many more marbles does Arun have?
- Arun has 17 marbles and Benni has 11 marbles. How many more marbles should Benni get to have just as many marbles as Arun?

Although all three of these problems can be solved by subtracting 11 from 17, children do not experience these problems in the same way. Children might solve the first problem by counting on from 11 or counting back from 17. They might solve the second problem by matching Arun's and Benni's marbles on a one for one basis and counting the extra 6 marbles. In terms of the third problem children would be most inclined to solve the problem by adding/counting on.

Consider the two problems below:

- Arun has R24. A packet of chips costs R3. How many packets of chips can he buy?
- Mother has 24 biscuits. She shares these equally among 3 children. How many biscuits will each child get?

Both of these problems are division problems, they have the structure $24 \div 3$. However children do not experience these problems in the same way. In terms of the first problem the child wants to know how many lots of R3 there are in R24. In determining an answer a child might count in 3s: 3; 6; 9; 12; ...; 24 keeping track on her fingers and conclude that Arun can buy 8 packets. The structure of the second problem is quite different. The child needs to determine how big each part is if there are 3 equal parts. In solving this problem the child might adopt an approach similar to the ones used by Sandla, Marie and Susan.

In order to develop:

- a sound understanding of the basic operations; and
 - a range of effective computational strategies
- children need to be exposed to a range of different types of problems.

For a discussion of the different problem types to which children in the Foundation Phase need to be exposed see the *guidelines for practice* below.

The role of problems in making the mathematical experiences of the child meaningful and relevant

Joslin is a Grade 2 girl in a class where children are seldom, if ever, exposed to problems.

When Joslin was asked to solve the problem: *Bradley has 16 marbles. If he wins another 25, how many marbles will he have?* She did not hesitate, she wrote $16 + 25 = 41$. She then looked at her neighbour's work and seeing that he had written 42 she changed her answer to 42. Ignoring this for a moment, we could at this stage (based on her answer) be forgiven for thinking that Joslin understands what she is doing.

Immediately after responding to the first problem, Joslin was asked to solve the problem: *There are 28 apples. If we put 3 in a packet, how many packets can we fill?* Once again Joslin hardly hesitated – she wrote: $28 + 3 = 31$.

Bradley has 16 marbles. If he wins another 25, how many marbles will he have?

$$16 + 25 = 41$$

Joslin

There are 28 apples. If we put 3 in a packet, how many packets can we fill?

$$16 + 25 = 41$$

$$28 + 3 = 31$$

Joslin

Joslin, despite being in Grade 2, has already stopped trying to make sense of the situation – she understands her role in mathematics as being to identify the numbers in the problem and to do something with them. It seems that on the day of these problems she regarded “plusing” as being the “thing” to do.

When asked to make a picture of the situation Joslin drew the picture alongside demonstrating quite clearly that she does have the capacity to make sense of a situation. However she does not regard this as what is expected of her.

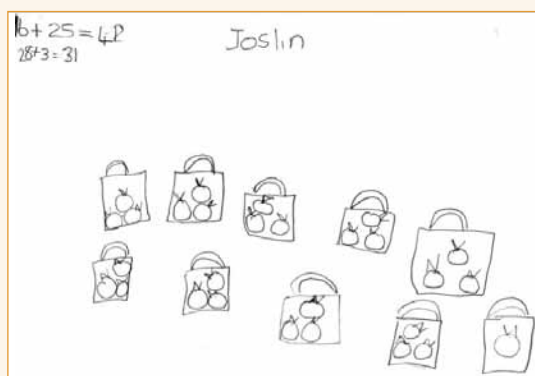

The story of Joslin illustrated above is not unusual – this lack of sense making and lack of engagement is evident in children who are exposed to mathematics as a formal set of rules from too early a stage rather than as a meaningful sense-making activity in their mathematical careers.

The examples of children’s work below could be explained as the result of children being taught that subtraction involves “taking a smaller number away from a larger number”.

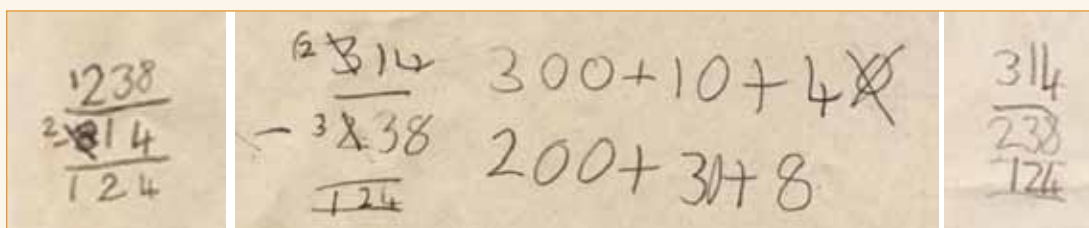

What do we know?

A key challenge for the Foundation Phase Numeracy teacher is to incorporate problems in all that she does with her learners.

We want teachers and learners to see the solution of problems as a vehicle for learning mathematics and not only as a purpose for learning mathematics. We want children to experience Mathematics as a meaningful, sense-making activity – an activity in which we solve worthwhile problems.

Linking to the strands of Mathematical Proficiency discussed in Unit 2, we can see that problems allow children to:

- **Understand** what they are doing;
- **Reason** about what they are doing;

- **Apply** what they have learnt;
- **Engage** with situations that they find meaningful and relevant; and
- Develop effective **computational** strategies.

Making problems an integral component of the Numeracy classroom has at least two key implications for the teacher:

- Teachers need to have a sense of the range of problems to be used in the classroom; and
- Teachers need to have a clear sense of how to support the children in their classes make progress – that is, they need to have a clear sense of a developmental trajectory along which we might expect learners to progress as they grow in confidence.

These implications are discussed in the next section.

Guidelines for practice

In this section we will discuss two key issues:

- The range of problem types appropriate to the Foundation Phase Numeracy classroom
- Developmental trajectories appropriate in the Foundation Phase Numeracy classroom

The range of problem types appropriate to the Foundation Phase Numeracy classroom

CAPS Unit 5, which deals with Content Area: Numbers, Operations and Relationships, does two key things:

- It highlights problems as central to the development of number concept specifically and Numeracy in general (see discussion in Unit 5); and
- It identifies the range of problems to be solved.

In terms of the problem types to be used in the numeracy classroom the following are identified in the curriculum (highlights added):

Grade R We know this when the learner:	Grade 1 We know this when the learner:	Grade 2 We know this when the learner:	Grade 3 We know this when the learner:
	<ul style="list-style-type: none"> • Solves money problems involving totals and change in Rands and cents 	<ul style="list-style-type: none"> • Solves money problems involving totals and change in Rands and cents 	<ul style="list-style-type: none"> • Solves money problems involving totals and change in Rands and cents, including converting between Rands and cents

Grade R We know this when the learner:	Grade 1 We know this when the learner:	Grade 2 We know this when the learner:	Grade 3 We know this when the learner:
<ul style="list-style-type: none"> Solves and explains solutions to practical problems that involve equal sharing and grouping with whole numbers to at least 10 and with solutions that include remainders 	<ul style="list-style-type: none"> Solves and explains solutions to practical problems that involve equal sharing and grouping with whole numbers to at least 34 and with solutions that include remainders 	<ul style="list-style-type: none"> Solves and explains solutions to practical problems that involve equal sharing and grouping and that lead to solutions that also include unitary fractions (e.g. $\frac{1}{4}$) 	<ul style="list-style-type: none"> Solves and explains solutions to practical problems that involve equal sharing and grouping and that lead to solutions that also include unitary and non-unitary fractions (e.g. $\frac{1}{4}$, $\frac{3}{4}$)
<ul style="list-style-type: none"> Solves verbally stated addition and subtraction problems with single-digit numbers and with solutions to at least 10 	<ul style="list-style-type: none"> Can perform calculations, using appropriate symbols, to solve problems involving: addition and subtraction with whole numbers and solutions to at least 34 repeated addition with whole numbers and with solutions to at least 34 estimation 	<ul style="list-style-type: none"> Can perform calculations, using appropriate symbols, to solve problems involving: addition and subtraction of whole numbers with at least 2-digit numbers multiplication of whole 1-digit by 1-digit numbers with solutions to at least 50 estimation 	<ul style="list-style-type: none"> Can perform calculations, using appropriate symbols, to solve problems involving: addition and subtraction of whole numbers with at least 3-digit numbers multiplication of at least whole 2-digit by 1-digit numbers division of at least whole 2-digit by 1-digit numbers estimation

In summary, the key problem types identified are:

- Problems that involve **sharing** and **grouping** – these problems introduce learners to the notion of division – an operation that is first mentioned formally in Grade 3.
- Problems that involve **addition** and **subtraction**
- Problems that involve **repeated addition** – these problems introduce learners to the notion of multiplication – an operation that is first mentioned formally in Grade 2.

What should be noted is that the curriculum talks about “*solving problems that involve...*” as opposed to listing addition, subtraction, multiplication and division as ends in themselves.

In exactly the way that the earlier discussion in this unit suggests that children can be introduced to the basic operations through problems so the curriculum also proposes such an approach.



It should also be noted that the curriculum mentions problems involving sharing and grouping before it mentions problems involving addition and subtraction – this is not coincidental. Problems involving sharing and grouping are mentioned before problems involving addition and subtraction expressly because young children relate more easily to situations that involve sharing (and grouping) than they do to situations that involve addition and subtraction.

Problems that involve sharing and grouping

Problems involving sharing are of the form:

- We have items that we want to share among children.
 - ▶ How can we share the items equally?
and/or
 - ▶ How many items will each person get?

Examples of sharing problems (note the numbers need to be adjusted to be Grade appropriate)

- Mary has 3 rabbits and 15 carrots. How many carrots can each rabbit get?
- Jenny has 4 chickens and 12 worms. How many worms can each hen get?
- There are 16 cookies. How can Kelly, Belinda, Vuyani and Sita share these equally between themselves?

Sharing problems with remainder appropriate to Grades R and 1

- ▶ Susan, Mary, Francis and Rohelna have 13 sweets. How can they share them equally?

Sharing problem with remainder appropriate to Grade 2 (i.e. leading to a unitary fraction)

- ▶ Susan, Mary, and Rohelna have 10 bars of chocolate. How can they share them equally among themselves?

Sharing problem with remainder appropriate to Grade 3 (i.e. leading to a non-unitary fraction)

- ▶ Susan, Mary, and Rohelna have 11 bars of chocolate. How can they share them equally among themselves?

Problems involving grouping are of the form:

- We have items with which we want to make groups of .
 - ▶ How many groups can we make?

Examples of grouping problems

- Billy must pack 10 apples into bags. He packs 2 apples in a bag. How many bags can he fill?

- Frank has 42 eggs. He packs these into egg boxes that hold 6 eggs each. How many egg boxes can he fill?
- Simphiwe has R25. A hamburger costs R5. How many hamburgers can he buy?
- Motle uses 2m of wire to make a car. If he has 19m of wire, how many cars can he make?

Grouping problems, remainders and fractions

Although it makes sense to have remainders when grouping it does not really make sense to use fractions to describe these remainders especially not in the Foundation Phase where such fractions are quite complex. For example when packing 50 eggs into egg boxes that hold 6 eggs each there will be 8 full boxes and 2 eggs left over. Although these two eggs represent one-third of a box of eggs, it is recommended that teachers do not engage with this in the Foundation Phase.

Problems that involve addition and subtraction

Addition and subtraction problems typically involve three quantities or values: **the starting value**; a **change** – the value/amount by which the starting value is changed (increased for addition/decreased for subtraction); and the **result**. This leads to the following general structure:

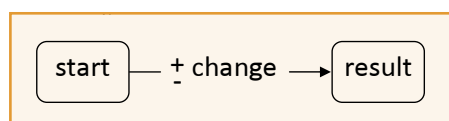

As the earlier illustration involving Arun and Benni revealed this basic structure leads to at least three situations that children experience as different – these are summarised below.

It is important that teachers expose children to a range of problems involving addition and subtraction that use these different structures.

Problems involving addition can take the following forms:

- Change – increase – result-unknown problems
 - ▶ These problems are the most typical problems involving addition that children come across. They are most often solved by means of adding-on (addition) and provide no significant challenge to learners in terms of them having to make a plan to solve the problem.

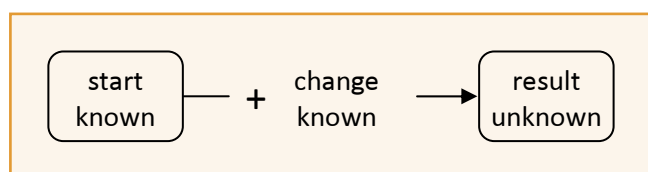

Examples of change – increase – result-unknown problems

- Ntatu has 2 sweets. Andile gives her 3 more. How many sweets does Ntatu have now?
- Xola comes to school with 18 marbles. If Xola wins another 14 marbles, how many marbles will he have altogether?
- Change – increase – change-unknown problems
 - ▶ These problems can be solved in a number of different ways, including: counting on (addition); counting back (subtraction); and by means of comparison

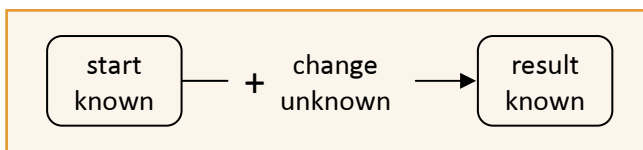
**Examples of change – increase – change-unknown problems**

- Xola comes to school with 18 marbles. He goes home with 32 marbles. How many marbles did he win during the day?
- There are 43 children in the class. The tuck-shop has already made 27 vetkoek. How many more vetkoek must the tuckshop make so that every child can get one vetkoek?
- Change – increase – start-unknown problems
 - ▶ These problems can be also be solved in a number of different ways, including: counting backwards (subtraction) and comparison

Examples of change – increase – start-unknown problems

- After winning 14 marbles during the day, Xola went home with 32 marbles. How many marbles did he come to school with?
- Lerato needs to grow another 10cm to be 150cm tall. How tall is Lerato now?
- Change – decrease – result-unknown problems
 - ▶ These problems are the most typical problems involving subtraction. They are most often solved by means of counting back (subtracting) and provide no significant challenge to learners in terms of them having to make a plan to solve the problem.

Examples of change – decrease – result-unknown problems

- Neo has 15 sweets. She gives Pula 8 of her sweets. How many sweets does she have left?
- There are 17 girls at the party. How many are left at the party after 6 of the girls go home?

- Change – decrease – change-unknown problems
 - ▶ These problems can be solved in a number of different ways, including: counting on (addition); counting back (subtraction); and by means of comparison

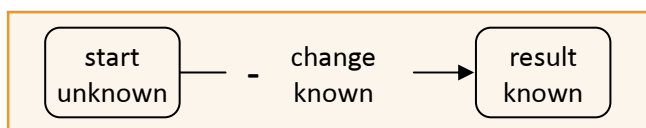

Examples of change – decrease – change-unknown problems

- Xola came to school with 23 marbles. He goes home with 14 marbles. How many marbles did he lose during the day?
- Mother baked 35 muffins. After the children had eaten some muffins there were only 12 muffins left over. How many muffins did the children eat?
- Change – decrease – start-unknown problems
 - ▶ These problems can be also be solved in a number of different ways, including: counting forwards (addition) and comparison

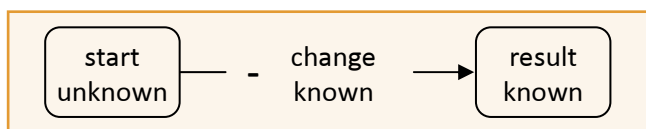

Examples of change – decrease – start-unknown problems

- After giving 6 marbles to Kanelo, Paki still has 15 marbles. How many marbles did Paki have to start with?
- After buying a radio for R32 Liwa still has R23 pocket money left. How much pocket money did Liwa get?

Problems that involve repeated addition leading to multiplication

Problems involving repeated addition are all of the form:

We have groups of items, how many items do we have altogether?

There are however two fundamentally different ways in which the problem can be phrased and hence experienced by children. The first of these invokes a grid representation whereas the second invokes an image of repeated addition.

Consider the question: *Sanele plants beans in her garden. She plants 7 rows with 12 bean plants in each row. How many bean plants has she planted?* This question invokes the image alongside. For the child with a well developed sense of number the solution can now be determined by skip counting in 7s or 12s and/or by adding

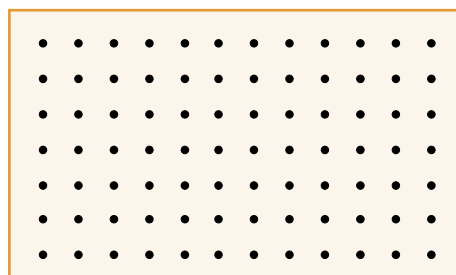

$12 + 12 + 12 \dots + 12$ (seven lots of 12) or by adding $7 + 7 + 7 + \dots + 7$ (twelve lots of 7) – helping children to develop the **logico-mathematical** (conceptual knowledge) that $12 \times 7 = 7 \times 12$.

By contrast consider the question: *How much will Karabo pay for 12 cans of cold drink if each can costs R7?* This question invokes the image alongside. Leaving children with only one real solution strategy: $R7 + R7 + R7 + \dots + R7$ (twelve lots of R7) – i.e. repeated addition.

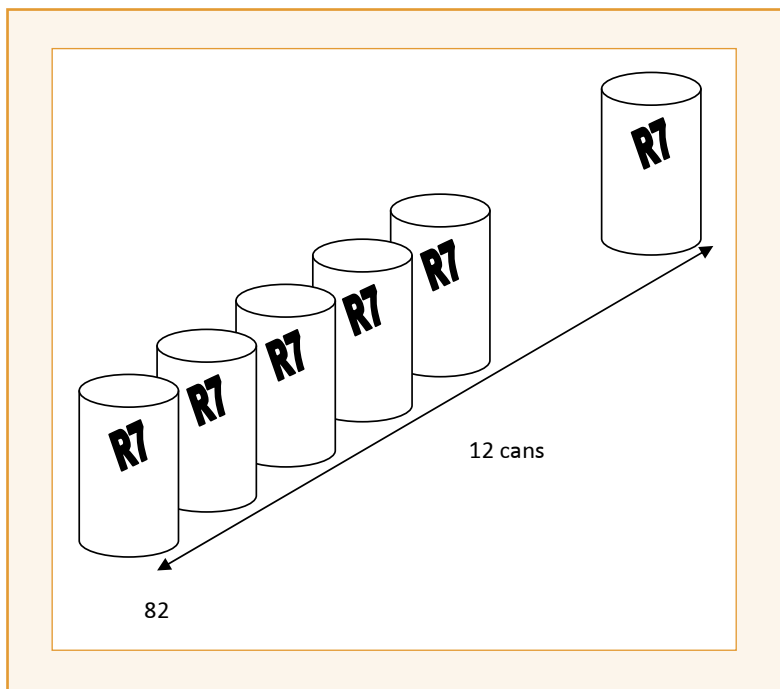

Developmental trajectories appropriate in the Foundation Phase Numeracy classroom

In addition to being aware of and planning to use the different problem types appropriate to the Foundation Phase, teachers also need to have a sense of how children will develop from their first primitive attempts at solving problems to the more sophisticated age-appropriate strategies that continue to make sense to them. We refer to the progression from primitive to sophisticated as a trajectory.

Although Marie's solution strategy (see earlier) made sense to her and enabled her to solve the problem it was probably not as sophisticated as we might have hoped for from a Grade 3 child towards the end of her Grade 3 year.

In order to support children along the path of gradual sophistication teachers need to do two things:

- Firstly, they need to have a mental image of a developmental "trajectory" along which they would expect children to develop; and

- Secondly, they need to use
 - ▶ Children’s explanations and comparisons of their strategies; and
 - ▶ Well chosen numerical values in problems
 to induce children to gradually increase the sophistication of their approaches.

By having a mental image of a developmental trajectory a teacher can observe the children as they solve problems and create impressions of them: noting which are more advanced in their approaches and which are still struggling.

While observing the children working on problems the teacher consciously selects solutions from those developed by the children to be presented to the other children. The teacher should select a number of different solution strategies ranging from the less sophisticated to the increasingly sophisticated deliberately omitting the least sophisticated. As children present their solution methods to each other so they help each other to become more sophisticated in their approach.

This presentation of solution methods by children is what was referred to as discussion in Unit 2 (page 19).

There is much to be gained from having a child with a solution strategy that does **not** work to explain their method – there is sometimes more to be learnt from mistakes than from perfect solutions!

The children’s work that follows illustrates a possible developmental trajectory for sharing problems.



In response to the question: *How should 17 cookies be shared equally among 4 children?* Sandla draws the four children and the 17 cookies and then allocates the cookies to the children on a one by one basis.

Comment: This approach is probably the most primitive approach that we should expect for a sharing problem – the method is not very systematic and the child is likely to get quite confused if he persists with this approach as the numbers get larger. To his credit Sandla’s drawing is less detailed than Eugene’s drawing in the next example which shows a slightly greater degree of sophistication.

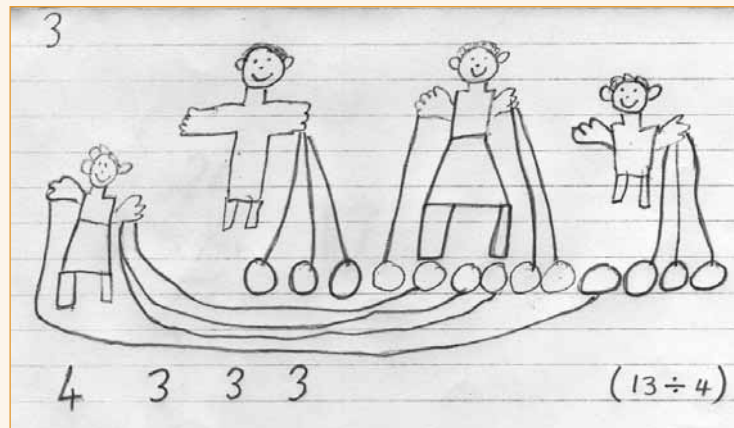

In response to the question: *How should 13 cookies be shared equally among 4 children?* Eugene draws four children and working in a somewhat unsystematic manner shares out the cookies and deals with the issue of a remainder by simply giving it to one of the children.

Comment: This approach which involves detailed drawings of the children and the drawing of each cookie is probably typical of a child starting out on the sharing/division trajectory. That said, it would appear as if Eugene already had some sense of the answer before he starts to illustrate it because he gives three cookies to each child as opposed to giving the cookies out on a one by one basis – we should guard against the situation arising where children will use a less sophisticated approach to solve a problem than the approach of which they are capable – some children will do this because they believe that the detailed drawing is what the teacher wants.

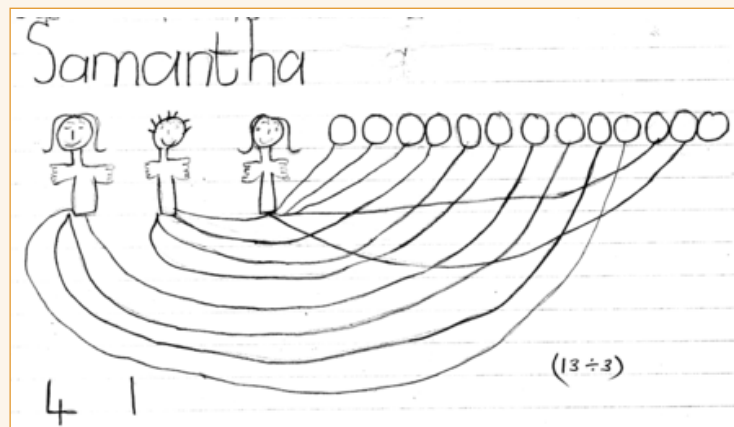

In response to the question: *How should 13 cookies be shared equally among 3 children?* Samantha draws the three children and each of the cookies. It would appear as if Samantha knows that each child will get more than one cookie – look carefully at the lines that she uses to allocate the cookies: she first gives each child three cookies and then resolves the issue of the remaining cookies.

Comment: Although Samantha's approach involves drawings that are possibly more detailed than necessary (for her stage of development) Samantha is starting to hand out the cookies in smaller groups rather than on a one by one basis and is clearly working in a more systematic manner than Sandla was in the first illustration – this definitely shows an increase in understanding.

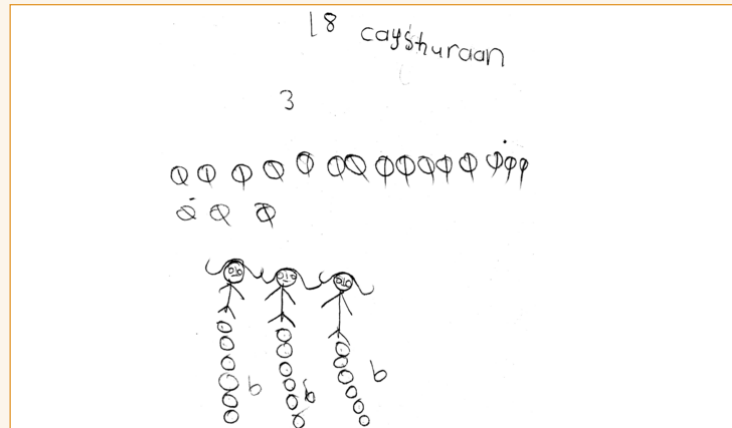

In response to the question: *How should 18 cookies be shared equally among 3 children?* Cayshuraan draws the three children and the 18 cookies and then shares the cookies out one by one systematically crossing out each of the cookies as she does so. She concludes that each child will get 6 cookies.

Comment: Although Cayshuraan is still handing out the cookies on a one by one basis she is working more systematically than Sandla was in the first example – notice how her work is less confusing than Sandla’s. Cayshuraan also does not draw as detailed a drawing of the children as Samantha and Eugene did which does show that she is starting to work a little more abstractly.



As discussed earlier in the unit, Sandla modifies his solution strategy and produces this drawing above.

Comment: Although Sandla, unlike Samantha, is still handing out the cookies on a one by one basis he no longer draws all the cookies before doing the sharing as Cayshuraan has done. This certainly suggests that he is gaining confidence – it is possible that with some larger numbers he may start allocating the cookies using a small group at a time as Samantha has done in the earlier example.

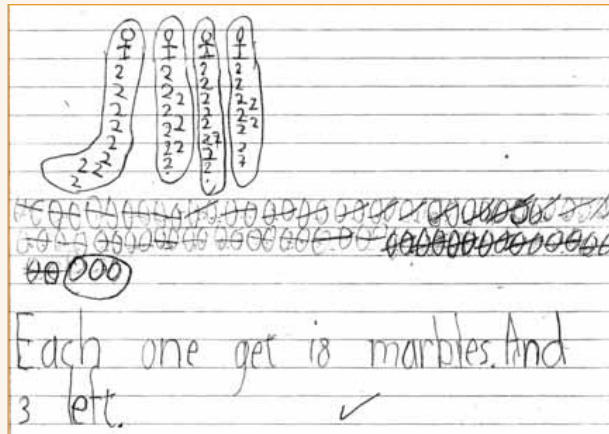

In response to the question: *How should 75 marbles be shared equally among 4 children?* Peter draws the four children and the 75 marbles he then shares the marbles out in pairs crossing out two marbles at a time and writing the number two under each child.

Comment: Peter is working more efficiently than Cayshuraan does because rather than allocating the marbles one at a time he does so two at a time. However it is probably because his sense of number is weak – Level 1 – that he has to first draw all 75 marbles. Although Peter’s solution strategy is a little more efficient, his progress is being hampered by his poorly developed sense of number.

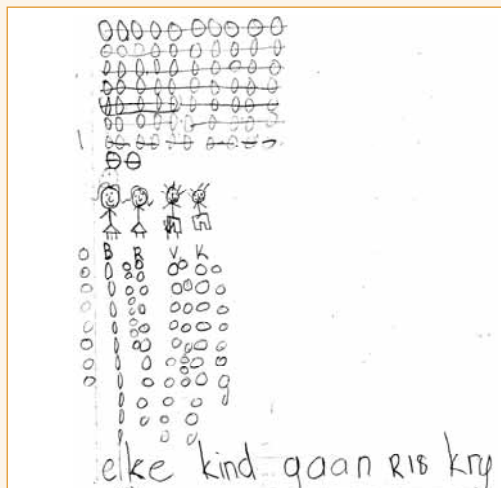

In response to the question: *How should R72 be shared equally among 4 children?* Marie draws the four children and the R72 and then (as described earlier) shares the Rands out. First she gives each child a row of ten, then she halves the number giving each 5 and “halves” again giving each child another two – finally she gives each child one last Rand

Comment: Marie is sharing out the Rands in larger groups at a time and furthermore is reacting to what she does at each iteration – i.e. she halves and so on. In this sense she is demonstrating quite some sophistication in terms of her understanding. However, probably like Peter, she lacks the number sense and hence confidence to record what she does in numbers. A clear illustration of how a weak number sense can limit a child’s ability to develop increasing levels of sophistication.

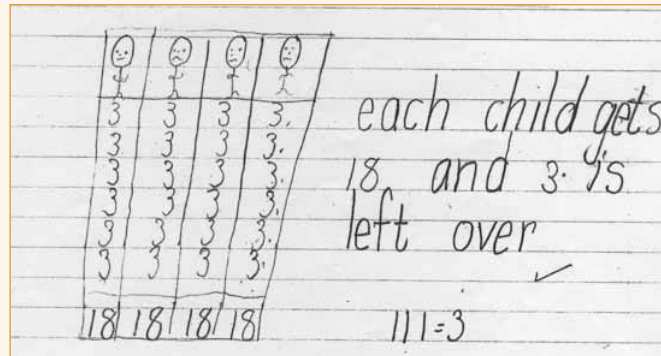

In response to the question: *How should 75 marbles be shared equally among 4 children?* Agatha draws the four children and allocates the marbles to the children in groups of 3.

Comment: By not first drawing the 75 marbles Agatha demonstrates that she can work with the 75 without first having to reconstruct the marbles – this would suggest that she is at least at Level 2 in terms of her number sense. However, she is definitely not at Level 3 yet because she is only working with groups of 3 rather than using larger values to start off with.

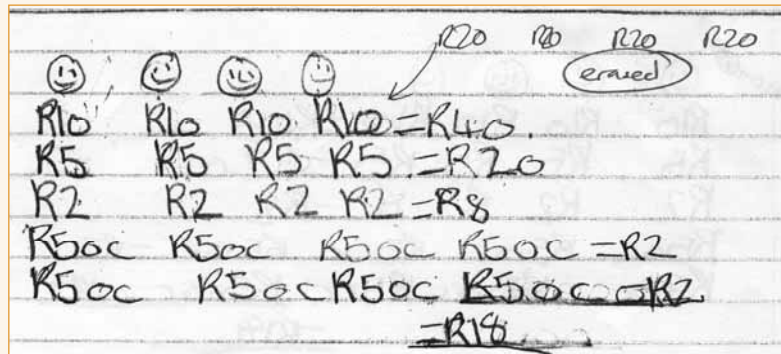

In response to the question: *How should R72 be shared equally among 4 children?* Susan (as described earlier) draws the faces of the four children and gives each child R20 – on reflection she realises that she has given away more Rands than she has and halves the allocation giving each child R10 and so on until she has given each child R18 and has no money left to share among the children.

Comment: Susan is definitely the most sophisticated of the children and her work probably illustrates as sophisticated an approach as we might expect of a child in the Foundation Phase. One of the reasons that Susan is able to work at this higher level of sophistication is as a result of her more developed sense of number.

Introduction

Numbers are the foundation of all mathematics and it is therefore not surprising that the first content area of CAPS deals with: *Numbers, Operations and Relationships*.

As already suggested earlier in this handbook children who leave the Foundation Phase with a weak sense of numbers will almost certainly not develop confidence in mathematics.

Of course it is not enough to only have a strong sense of number; children also need to be able to use numbers to solve problems and to make sense of the world in which they live. In order to be able to use numbers to solve problems and make sense of their world; children need extended opportunities to work with numbers.

The content, concepts and skills for the Content Area: Numbers, Operations and Relationships have been developed expressly to encourage an interaction between the development of number sense and the ability to work with numbers (perform operations etc.) in order to make sense of the world and solve problems.

What we know

The key challenge is for children to experience numeracy as meaningful.

In order to do so they need to **understand** what they learn, to be able to **apply** their learning, they need to be able to reason about and reflect on their practice and of course they need to learn how to compute with fluency.

It is important for teachers to realise that in the Foundation Phase in particular; children develop their ability to compute from **experiences** that cause them to **reason, apply** and **understand** (recall Odwa and Asevelo as well as the sharing trajectory described in Unit 4). In other words, children in the Foundation Phase develop their sense of what it means to operate on number through solving problems using a wide range of techniques and strategies.

Table 1 provides a graphical representation of how problem solving should be approached in each grade.

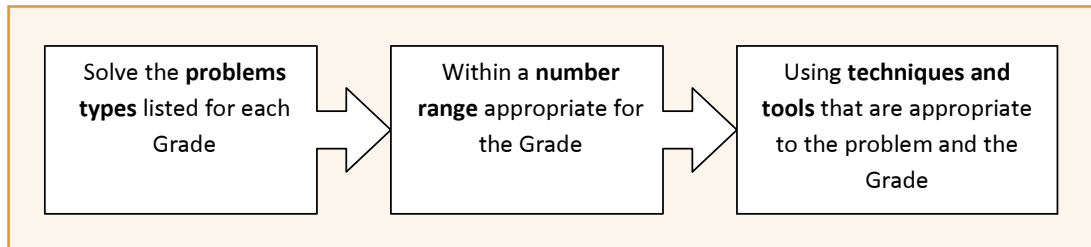

It is possible to link these clusters directly to the three key elements of teaching and learning Numeracy identified in Unit 2:

- The development of a **strong sense of number – Number Range** – see also Unit 3
- The use of **meaningful and realistic problems – Problem Types** – see also Unit 4
- The role of **discussion – Techniques and Tools** – techniques and tools provide the means for solving problems within an appropriate number range. They also provide children with a way for reflecting on their plans and methods as well as analyzing the plans and methods of their peers. In order to describe their plans and methods children are forced to reflect on what they did and in doing so to understand their methods better. Furthermore, through reflection children are also able to justify the validity, or not, of their solution.

Number Range

- The extent (10 in Grade R, 34 in Grade 1 and 100 in Grade2) to which children are expected to be able to **rationally count reliably** is reflected in the number range of the problem types describe for these grades, and
- The use of concrete apparatus is listed as a tool/technique to be used in solving problems (a technique that is not listed in Grade 3)

Table 1: Numbers, Operations and Relationships

The learner is able to recognise, describe and represent numbers and their relationships, and counts, estimates, calculates and checks with competence and confidence in solving problems				
	Grade R We know this when the learner:	Grade 1 We know this when the learner:	Grade 2 We know this when the learner:	Grade 3 We know this when the learner:
Number Range	<ul style="list-style-type: none"> Counts to at least 10 everyday objects reliably 	<ul style="list-style-type: none"> Counts to at least 34 everyday objects reliably 	<ul style="list-style-type: none"> Counts to at least 100 everyday objects reliably 	
	<ul style="list-style-type: none"> Says and uses number names in familiar contexts Knows the number names and symbols for 1 to 10 	<ul style="list-style-type: none"> Counts forwards and backwards in: <ul style="list-style-type: none"> ones from any number between 0 and 100 tens from any multiple of 10 between 0 and 100 Knows and reads number symbols from 1 to at least 100 and writes number names from 1 to at least 34 	<ul style="list-style-type: none"> Counts forwards and backwards in: <ul style="list-style-type: none"> ones from any number between 0 and 200 tens from any multiple of 10 between 0 and 200 fives from any multiple of 5 between 0 and 200 twos from any multiple of 2 between 0 and 200 Knows and reads number symbols from 1 to at least 200 and writes numbers names from 1 to at least 100 	<ul style="list-style-type: none"> Counts forwards and backwards in: <ul style="list-style-type: none"> the intervals specified in Grade 2 with increased number ranges twenties, twenty fives, fifties and hundreds between 0 and at least 1000 Knows number names from 1 to at least 10 in the mother tongue (if not the language of instruction) and one other local language Knows, reads and writes number symbols and names from 1 to at least 1000
	<ul style="list-style-type: none"> Orders and compares collections of objects using the words: more, less and equal 	<ul style="list-style-type: none"> Orders, describes and compares whole numbers to at least 2-digit numbers 	<ul style="list-style-type: none"> Orders, describes and compares the following numbers: <ul style="list-style-type: none"> whole numbers to at least 2-digit numbers common fractions including halves and quarters 	<ul style="list-style-type: none"> Orders, describes and compares the following numbers: <ul style="list-style-type: none"> whole numbers to at least 3-digit numbers common fractions including halves, quarters and thirds
			<ul style="list-style-type: none"> Recognises the place value of digits in whole numbers to at least 2-digit numbers 	<ul style="list-style-type: none"> Recognises the place value of digits in whole numbers to at least 3-digit numbers

Table 1: Numbers, Operations and Relationships (continued)

The learner is able to recognise, describe and represent numbers and their relationships, and counts, estimates, calculates and checks with competence and confidence in solving problems				
	Grade R We know this when the learner:	Grade 1 We know this when the learner:	Grade 2 We know this when the learner:	Grade 3 We know this when the learner:
Problem Types	<ul style="list-style-type: none"> Solves and explains solutions to practical problems that involve equal sharing and grouping with whole numbers to at least 10 and with solutions that include remainders 	<ul style="list-style-type: none"> Solves money problems involving totals and change in Rands and cents 	<ul style="list-style-type: none"> Solves money problems involving totals and change in Rands and cents 	<ul style="list-style-type: none"> Solves money problems involving totals and change in Rands and cents, including converting between Rands and cents
		<ul style="list-style-type: none"> Solves and explains solutions to practical problems that involve equal sharing and grouping with whole numbers to at least 34 and with solutions that include remainders 	<ul style="list-style-type: none"> Solves and explains solutions to practical problems that involve equal sharing and grouping and that lead to solutions that also include unitary fractions (e.g. $\frac{1}{4}$) 	<ul style="list-style-type: none"> Solves and explains solutions to practical problems that involve equal sharing and grouping and that lead to solutions that also include unitary and non-unitary fractions (e.g. $\frac{1}{4}$, $\frac{3}{4}$)
	<ul style="list-style-type: none"> Solves verbally stated addition and subtraction problems with single-digit numbers and with solutions to at least 10 	<ul style="list-style-type: none"> Can perform calculations, using appropriate symbols, to solve problems involving: <ul style="list-style-type: none"> addition and subtraction with whole numbers and solutions to at least 34 repeated addition with whole numbers and with solutions to at least 34 estimation 	<ul style="list-style-type: none"> Can perform calculations, using appropriate symbols, to solve problems involving: <ul style="list-style-type: none"> addition and subtraction of whole numbers with at least 2-digit numbers multiplication of whole 1-digit by 1-digit numbers with solutions to at least 50 estimation 	<ul style="list-style-type: none"> Can perform calculations, using appropriate symbols, to solve problems involving: <ul style="list-style-type: none"> addition and subtraction of whole numbers with at least 3-digit numbers multiplication of at least whole 2-digit by 1-digit numbers division of at least whole 2-digit by 1-digit numbers estimation

Table 1: Numbers, Operations and Relationships (continued)

The learner is able to recognise, describe and represent numbers and their relationships, and counts, estimates, calculates and checks with competence and confidence in solving problems				
	Grade R We know this when the learner:	Grade 1 We know this when the learner:	Grade 2 We know this when the learner:	Grade 3 We know this when the learner:
Tools/techniques		<ul style="list-style-type: none"> Performs mental calculations involving addition and subtraction for numbers to at least 10 	<ul style="list-style-type: none"> Performs mental calculations involving: <ul style="list-style-type: none"> addition and subtraction for numbers to at least 20 multiplication of whole numbers with solutions to at least 20 	<ul style="list-style-type: none"> Performs mental calculations involving: <ul style="list-style-type: none"> addition and subtraction for numbers to at least 50 multiplication of whole numbers with solutions to at least 50
	<ul style="list-style-type: none"> Uses the following techniques: <ul style="list-style-type: none"> building up and breaking down numbers to at least 10 doubling and halving to at least 10 using concrete apparatus e.g. counters 	<ul style="list-style-type: none"> Uses the following techniques: <ul style="list-style-type: none"> building up and breaking down numbers doubling and halving using concrete apparatus e.g. counters number-lines 	<ul style="list-style-type: none"> Uses the following techniques: <ul style="list-style-type: none"> building up and breaking down numbers doubling and halving using concrete apparatus e.g. counters number-lines 	<ul style="list-style-type: none"> Uses the following techniques: <ul style="list-style-type: none"> building up and breaking down numbers doubling and halving number-lines rounding off in tens
	<ul style="list-style-type: none"> Explains own solutions to problems 	<ul style="list-style-type: none"> Explains own solutions to problems 	<ul style="list-style-type: none"> Explains own solutions to problems 	<ul style="list-style-type: none"> Explains own solutions to problems
		<ul style="list-style-type: none"> Checks the solution given to problems by peers 	<ul style="list-style-type: none"> Checks the solution given to problems by peers 	<ul style="list-style-type: none"> Checks the solution given to problems by peers

The message is clear – children should be able to **count rationally** so that they can use rational **counting** as a technique for **solving problems**. Of course the solving of problems also provides children with a reason to count objects rationally.

Rote Counting (counting forwards and backwards) skills and social knowledge (knowing, reading, writing number names) are dealt with in Number, Operations and Relationships.



The Grade 2 and Grade 3 mathematical content that addresses the recognition of place value supports the development of **Level 3** number development as it supports the child's ability to break down numbers. It is important, as a teacher, to recognise that this does not mean that children should be expected to write two- or three-digit numbers in terms of **Hundreds**, **Tens** and **Units** as this is not something that makes sense to children who are still working at **Level 3**. Rather, the Assessment Standard refers to the ability of children to recognise that $78 = 70 + 8$ and $112 = 100 + 10 + 2$. Refer to the discussion on **Flard cards** in Unit 3 in this regard.

The mathematical content that deals with the *ordering and comparing* of numbers in each Grade supports the development of **Level 3** number sense through encouraging the development of the mental number line described in Unit 3. The way in which children will break down and build up numbers is guided by a number of things which include the actual numbers in the problem that they are solving and the operation that they are performing. A mental (or written) number line is crucial in this regard.

To solve the problem:
Odwa brought 17 marbles to school and went home with 89. How many marbles did he win? A child might draw or imagine a number line and use it as illustrated above.

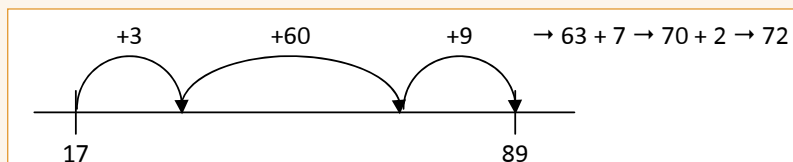

By contrast in solving the problem: *Odwa brought 89 marbles to school and won another 17. How many marbles does he have now?* A child might draw or imagine a number line and use it as illustrated alongside.

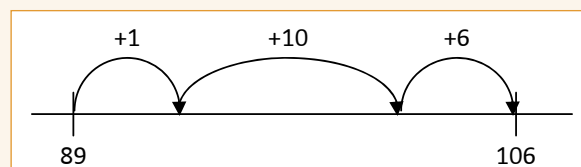

In order to make a plan to solve these two problems the child would, in the first example, need to have a sense of the relative positions on the number line of the start and end points and then be able to count on in efficient ways, whereas in the second problem the child needs to have a sense of the starting value and must be able to break down the other number in response to the starting number in order to achieve the answer. Both solutions rely on the child's ability to order and compare numbers.

Problem types

There are a few significant aspects in this cluster that should be noted:

- CAPS deliberately speaks about **problems** ("practical problems" and "problems") as opposed to talking about addition, subtraction, multiplication and division as ends in themselves – the use of the word problem is quite deliberate. Children:
 - ▶ Are introduced to the four basic operations through problems;

- ▶ Develop more efficient calculating techniques and problem solving strategies because of the evolving nature of the problems across the Phase; and
- ▶ Experience numeracy/mathematics as meaningful as the result of solving problems
(See the discussion on the role of problems in Unit 4.)
- In all of the Grades problems involving equal sharing and grouping are mentioned first – this is also quite deliberate.
 - ▶ Children in the Foundation Phase find sharing and grouping problems quite a lot more accessible than problems that can be solved through addition and/or subtraction – this is in part because sharing is a natural part of their day to day experiences and also because sharing and grouping problems give a clearer more obvious sense of what the child needs to do in order to solve the problem than addition and subtraction problems do. In other words children find it easier to “make a plan” for solving sharing and grouping problems.
- All references to sharing and grouping refer to remainders right from Grade R. This is, once again, deliberate. Unless children experience sharing/grouping problems with remainders from an early stage they will develop the limiting belief that “if there is a remainder then it is not a division problem”.
- In Grades 2 and 3, the remainder is in turn also shared among the people doing the sharing and this leads to the introduction of fractions in the Foundation Phase.
 - ▶ In Grade 2 problems deal with for example 3 people sharing 4 bars of

CAPS uses the words addition and subtraction, repeated addition (a precursor to multiplication), sharing and grouping (pre-cursors to division) and in Grade 2 multiplication and Grade 3 division. This is so that teachers have a sense of the problem types to be addressed (see Unit 4).

The use of these words forms part of the professional discourse between the curriculum document and the teacher.

There is no expectation whatsoever that lesson in the Foundation Phase will begin with a heading on the board “addition” and then an exposition on how to “add”.

What the document is saying is that teachers should set problems (through words and within contexts that make sense to the child). Problems should **invoke** the child to use addition, subtraction, multiplication and division strategies.

With time we describe what the children are doing as addition and subtraction etc. – that is, we introduce the **social knowledge** (the labels) and of course we teach the children the notations – more social knowledge – so that they can record their thinking in ways that allow others to read what they have written (see remarks on written work and recording of work in Unit 10).

These remarks above should not be misinterpreted to mean that children in the Foundation Phase will never be asked to complete the number sentence: $3 + \square = 7$; $\square + 5 = 11$; and $15 = \square + 2$. They should be! They do so as they complete tasks that support their development of number sense (see Unit 3) and as they learn, practice and consolidate their number relationships. Numbers sentences are also used a great deal in Learning Outcome 2 (see Unit 6) where patterns are used to support the development of **conceptual/logi-comathematical** understanding with respect to numbers.

chocolate between themselves. Each person gets one bar of chocolate and there is one bar left over. To share this bar among the three people it must be cut into three equal pieces: each piece is called one-third (a unitary fraction).

- In Grade 3 problems deal with for example 3 people sharing 5 bars of chocolate between themselves. Each person again gets one bar of chocolate and there are two bars left over. To share these bars among the three people each must be cut into three equal pieces. The resulting 6 pieces are shared among the 3 people and each person gets two pieces – they get two one-thirds or two-thirds (a non-unitary fraction).
- Other than the addition of the words multiplication in Grade 2 and division in Grade 3 there is not a lot that is different between the Problem Types cluster from one Grade to the next. This is largely because the progression from one Grade to the next lies in both the increasing number range and the expectation that children will be working at more sophisticated levels of number development (see Unit 3) and using more efficient solution strategies (see discussion on tools and techniques below).
- Money problems play an important role is linking the child’s experiences of the world to the classroom and also of introducing the notion of different units and the conversion between these: Rands to cents and back. It is expected that just as children will count concrete objects in Grades R, 1 and 2 to solve problems so they will also work with artificial coins and notes in solving the money problems in these Grades.

For a more detailed discussion of the problem types refer to Unit 4.

Tools and Techniques

There are essentially four or five different tools and techniques listed that children in the Foundation Phase are expected to be able to use as they solve problems.

It should be noted that the tools and techniques described are all “informal tools and techniques”. Informal in the sense that there is no mention of column algorithms (which are mentioned for the first time in Grades 5 and 6) or other taught algorithms for performing the basic operations. They are also informal in the sense that there are no well developed writing traditions associated with these tools and techniques.

Although the tools and techniques listed in the curriculum for the Foundation Phase are informal, this does not in any way suggest that children are not expected to become more efficient in their approaches and/or to learn how to describe their thinking.

The purpose in using informal techniques is to allow children the opportunity to:

- Make sense; and
- Choose tools or techniques with which they are comfortable and which most effectively help them to solve the problems.



While it may be tempting to teach formal algorithms such as column addition from an early age – there is abundant evidence that children in the Foundation Phase cannot make sense of these algorithms yet and use them only in a mechanistic way – making more errors than not.

A Grade 3 class has been asked to solve the problem: Susan is selling vetkoek. If she has 47 vetkoek and places three in a packet, how many packets can she fill?

The solutions of three of the children are shown below – notice how these children regard their role as being to represent the problem as a “sum” (using a column layout) and then to “find the answer”. Two of the children choose an in appropriate operation and none of the children can perform the algorithm.

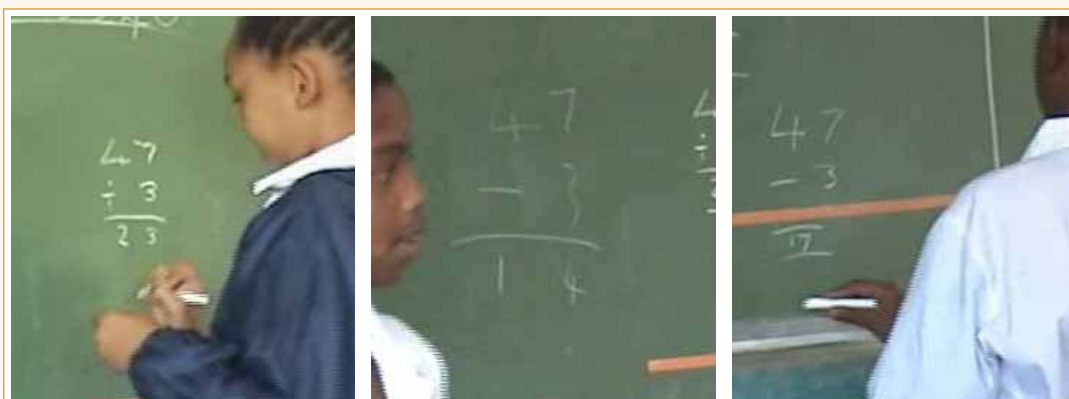

$$47 \div 3 = 23$$

$$47 - 3 = 14$$

$$47 - 3 = 17$$

Using concrete apparatus (e.g. counters): The use of concrete apparatus is probably the most primitive of strategies used by children. At first children will use their fingers and then, as the numbers get larger they will first use counters and from there progress to drawings to solve their problems.

The drawings that children draw tend to evolve from complicated and detailed drawings to more simple representations of the situation, for example at first children will draw the people in the problem with all of their clothes, hair and jewellery, however with time they become confident and simply represent the person by means of a face without too much detail.

It is critical that children in Grade R and Grade 1 have direct access to counters, counting frames and other apparatus for solving their problems. During Grade 1 and certainly by Grade 2 children should be encouraged to move away from the concrete apparatus to pictorial representations – note that these pictorial representations still represent the use of concrete apparatus (counters etc) but the children are drawing their own.

Using concrete apparatus (counters) and representations of concrete apparatus.



Solving a problem using counters.

Solving a problem by means of a detailed representation of the situation.

Solving a problem by means of a more compact representation of the situation.

Number-lines: As children move from a Level 1 sense of number to a sense of numbers at Levels 2 and 3 (see Unit 3) so they are developing a “mental number-line”. They are:

- Developing a sense of the relative sizes of numbers;
- Able to order numbers; and
- Starting to develop strategies to move with some comfort from one number to another (see *moving up and down the number line* – Unit 3).

In order both to record their thinking and also to allow them to keep track of their thinking (at first they cannot do all of this in their heads), we need to introduce children to a number-line and we need to encourage them to use it efficiently.

At first we might use a number lines with all of the numbers shown on it – such a number-line might well be displayed along the top of the board in the classroom. With time, however, children need to move away from number-lines that include each and every number and start using “blank number lines” on which they could identify say the starting number and result and then determine how to get from the one to the other.

Number-lines are simply a way of recording and managing the thought process that is going on in the mind of the child who is starting to work and/or is working with a Level 3 number sense.

Teachers should be aware that number-lines are probably more useful when solving addition and subtraction type problems and not that useful when solving sharing and grouping problems. Counting frames (which are a kind of number line) may initially be helpful as children solve sharing and grouping problems.

Problem	Possible number-line solutions
<p>Xola came to school with 23 marbles. He goes home with 14 marbles. How many marbles did he lose during the day?</p>	
<p>After putting 16 more apples into the basket there are now 34 apples in the basket. How many apples were there in the basket to begin with?</p>	
<p>28 children went on an excursion today. There are still 118 children at school. How many children were there to begin with?</p>	

Doubling and halving: Doubling and halving, doubling, and halving are all techniques that children will develop as they become more confident in their solving of sharing, grouping and multiplication type problems.

At first they are likely to share the items on a one-by-one basis. Next they will do so in groups of say two or three at a time. As the numbers in the problems get larger and as the children gain confidence so they will start to use numbers rather than sticks or circles to represent the items being shared. At this stage they are developing thought processes involving what can be described broadly as doubling and halving.

When sharing a large amount of items children may try to give each person 10 items at once but realising that there are not enough items to do so they may try five items each instead – halving the allocation per person and hence the total number of items that they have given out. Alternatively they may give each person 10 items and realising that they still have many items left over they might choose to give 20 or even 40 items to each person in the next round – doubling the allocation per person and hence the total number of items given out.

It is probably more realistic to expect that children will use doubling and halving with sharing, grouping, and repeated addition type problems than they will with addition and subtraction problems.



$$9 + 9 = 18 + 18 = 36 + 36 = 72 + 9 = 81 + 9 + 4 + 12 + 14 + 9 = 135$$

15 sabbies

Junaid

Problem: 135 apples are packed into bags. There are 9 apples in a bag. How many bags can be filled. In solving this problem Junaid uses doubling until he reaches 72 and then counts on in 9s and 18s until he reaches 135 and concludes that 15 packets will be filled. Notice how he keeps track of the number of bags filled.

$$\cancel{R25 + R25 + R25 + R25 + R25 + R25 = R150}$$

50 50 50

Sonja is calculating $6 \times R25$. To do so she first "doubles" R25 to get R50 and then adds the three R50 together to get her answer.

$$R18 + R18 + R18 + R18 + R18 + R18 =$$

16 16 16

$$10 + 10 + 10 + 10 + 10 + 10 = 60$$

$$10 + 10 + 10 = 30$$

$$6 + 6 = 12 \rightarrow 12$$

$$6 + 6 + 6 = 18$$

$$30 + 10 + 8 = 48$$

$$60 + 48 = 108$$

60
16
18
12
10

Tristen uses a combination of doubling and breaking down and building up to calculate $6 \times R18$. He writes down the six 18s and recognises that doubling the 8s of the 18s will give him three lots of 16. He then adds the six 10s of the 18s to get 60. It remains to add the three 16s. He does so by first adding the three 10s to get 30, then adding the three 6s to get 18 which he again break up into 10 and 8 so that he can add 30 and 10 and 8 to get 48 which he adds to the 60 from earlier to get 108.

$$10+10+10+10+10+10=60 \quad 10+10$$

$$60+20=80 \quad +6=86 \quad +8=94$$

$$60+20=80$$

$$6+8=14$$

$$14-10=4$$

$$80+10=90$$

$$90+4=94$$

Two Grade 2 children are solving a problem which involves determining the value $66 + 28$. The child whose writing is shown on the left breaks the numbers into 10s and then counts in tens before adding the 6 and the 8. The child whose work is shown on the right is working in a more sophisticated way. She breaks the numbers into $60 + 6$ and $20 + 8$ and then uses her knowledge of combinations of single-digit numbers ($8 + 6 = 14$) and combinations of multiples of ten ($60 + 20 = 80$) as tools for determining 94 as her answer.

Porché

$$38+2=40+60+14$$

$$2+60+14=76$$

$$238+2 \rightarrow 240+60 \rightarrow 300+14$$

Porché (Grade 3) is solving the problem: *Mr Bungane earns R314 and Mr Cyster earns R238. How much more does Mr Bungane earn?* Porché solves the problem by "adding on" from 38 to 40, to the next 100 and then a further 14. She combines the parts and determines that Mr Bungane earns R76 more and verifies her answer.

R 555 R 375

$$375+25 \rightarrow 400+100 \rightarrow 500+55=555$$

$$25+50 \rightarrow 75+5 \rightarrow 80+100 \rightarrow 180 \text{ meer}$$

R 180

Alida (Grade 3) is solving the problem: *Mr Cweya earns R555 and Mr Mtati earns R375. How much more does Mr Cweya earn?* Alida solves the problem by "adding on/building up" from 375 to 400, from 400 to 500, and from 500 to 555. He combines the parts 25 and 50 (from 55), then he adds the 5 left over from the 55 and finally adds 100, in so doing he determines that Mr Cweya earns R180..

Jana

$$50+50 \rightarrow 100+20 \rightarrow 120+10 \rightarrow 130+8 \rightarrow 138+6 \rightarrow 144$$

$$76 \times 68 = 144$$

144 meisies speel netball

Jana (Grade 3) is solving the problem: *There are 76 girls who play netball at our school. Another school brings 68 girls to the tournament. How many girls are there altogether?* Jana solves the problem by "breaking the numbers down" in her mind; rearranging and pieces and building up the answer. She adds 50 from each number and gets 100 she then adds 20 from the 76 and gets 120, she adds 10 from the 68 to get 130 and finally adds the 8 from the 68 and the 6 from the 76 to get her answer: 144.

$$70 \div 5 = 14$$

$$50 \div 5 = 10 \quad 20 \div 5 = 4 \quad 10 + 4 = 14$$

Thomas (Grade 3) is solving problem which involves determining the value of $70 \div 5$. He breaks the 70 into 50 and 20. Divides each by 5 and adds the 10 and 4 together to determine that the answer is 14.

Guidelines for practice

What the discussion above has highlighted is that the skills and concepts for Numbers, Operations and Relationships are taught in an integrated way:

We solve a range of problems in a Grade appropriate number range using tools and techniques that are informal but which become increasingly sophisticated as the child gains confidence in using them and develops a more sophisticated sense of number.

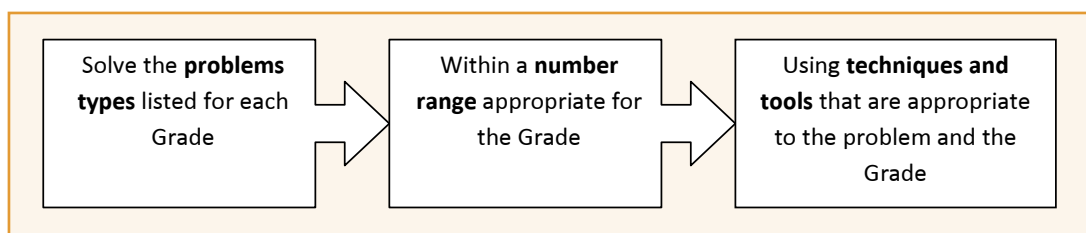

In order to most effectively help children achieve the requirements of the Assessment Standards of Learning Outcome 1 teachers will need to organise their classes in such a way that they work with small groups of children on the mat on a regular basis while the rest of the children are productively engaged in meaningful activity at their tables (seatwork).

Activities on the mat	Seatwork activities
<p>The teacher needs to arrange the children in her class according to their levels of development with respect to number sense – with children at the same stage of development in the same group</p> <p>Each group needs to work with the teacher on the mat at least three to four times a week with each mat session lasting typically 20 to 25 minutes.</p> <p>Each session on the mat is should include the following aspects.</p> <ul style="list-style-type: none"> ● Counting <ul style="list-style-type: none"> ▶ Rote ▶ Rational ● Breaking down and building up numbers <ul style="list-style-type: none"> ▶ Up and down the number line/ladder ▶ Flard cards 	<p>While some children are working on the mat with the teacher the remaining children need to be sitting at their tables productively engaged in activities that support the activities that the teacher is doing on the mat.</p> <p>It makes sense for the children at the tables to be organised in such a way that children at different stages of development sit together. This will enable these children to help each other in case they get stuck.</p> <p>The activities for seatwork can be in the form of:</p> <ul style="list-style-type: none"> ● Exercises from the textbook/workbooks ● Worksheets ● Activity cards ● etc

Activities on the mat	Seatwork activities
<ul style="list-style-type: none"> ● Problems <ul style="list-style-type: none"> ▶ See discussion of problems in Unit 4 ▶ Money problems <p>The distribution of time between counting, breaking down and building up numbers and solving problems is determined by the developmental stage of the children in the group.</p> <p>For children who still need to achieve or who have a Level 1 sense of number the time will be evenly distributed between counting and solving problems.</p> <p>With children who are progressing toward a Level 2 or Level 3 sense of number the time will be evenly distributed between the three key activities. The types of the counting activities now include skip counting as well as counting on.</p>	<p>With these activities including:</p> <ul style="list-style-type: none"> ● Counting <ul style="list-style-type: none"> ▶ Rational ● Breaking down and building up numbers <ul style="list-style-type: none"> ▶ Completing tables ▶ Completing patterns ▶ Completing flow diagrams ▶ Completing number chains ▶ Completing Pyramids ● Problems

Extensive examples of counting and breaking down and building up number activities have been discussed in Unit 3.

- Activities to support children who still need to achieve or who have only just achieved a **Level 1 sense of number** see page 26.
- Activities to support children who are progressing towards a **Level 2 or Level 3 sense of number** see page 37.

For an extensive discussion of problems refer to Unit 4.

Teaching Fractions in the Foundation Phase

Although fractions are not given a lot of attention in the Foundation Phase, the way in which Foundation Phase teachers treat and introduce fractions has a significant impact on how children understand fractions and calculations involving fractions in the later grades and even in high school.

Grade R We know this when the learner:	Grade 1 We know this when the learner:	Grade 2 We know this when the learner:	Grade 3 We know this when the learner:
		<ul style="list-style-type: none"> ● Orders, describes and compares the following numbers: <ul style="list-style-type: none"> ▶ whole numbers to at least 2-digit numbers ▶ common fractions including halves and quarters 	<ul style="list-style-type: none"> ● Orders, describes and compares the following numbers: <ul style="list-style-type: none"> ▶ whole numbers to at least 3-digit numbers ▶ common fractions including halves, quarters and thirds
		<ul style="list-style-type: none"> ● Solves and explains solutions to practical problems that involve equal sharing and grouping and that lead to solutions that also include unitary fractions (e.g. $\frac{1}{4}$) 	<ul style="list-style-type: none"> ● Solves and explains solutions to practical problems that involve equal sharing and grouping and that lead to solutions that also include unitary and non-unitary fractions (e.g. $\frac{1}{4}$, $\frac{3}{4}$)

The way in which children are exposed to fractions can contribute to problems in the following ways:

- At home children usually only hear about halves and quarters, and these parts are seldom **exactly** partitioned out. As a result children frequently refer to “the bigger half”! Half a glass of water is seldom exactly half-full, and a quarter is used to refer to a piece that is smaller than a half.

At school, when teachers limit their teaching to halves and quarters for a long time, children believe that these are the only fractional parts that you can get. For this reason it is critical that right from the start we introduce children to a wide range of fractions.

- If the fraction symbols are introduced before children have a really good understanding of what they are actually dealing with, they perceive the numerator and denominator as two separate numbers that are to be dealt with separately. For this reason, it is advised that the use of the fraction notation be delayed and that children are first taught to write the fraction in words e.g. one-third and one-fifth.
- When the teacher uses pre-partitioned materials to **demonstrate** fractions, children don’t actually know what they have to focus on. For example, if the teacher shows the drawing alongside to illustrate a quarter, many children understand that the whole picture is the quarter, and not just the shaded part. For this reason, it is advised that children make their own drawing and that these drawings are drawn for the purpose of solving problems.

$$\frac{3}{10} + \frac{3}{4} = \frac{9}{20}$$

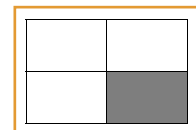

- If the teacher only uses single objects as the unit to be broken up into fractional parts, children find it extremely difficult to understand at a later stage in their development that collections of objects can also be partitioned, e.g. half of the class, a third of my pocket money etc. For this reason, it is advised that children are exposed to fractions both as a part of a whole and as a part of a collection from early on.

Fractions are best introduced through (as the curriculum suggests) sharing problems that lead to solutions that also include fractions.

The following two problems can be posed as initial problems:

1. Two friends want to share three chocolate bars between the two of them so that they each get exactly the same amount of chocolate and no chocolate is left over. How can they do this?
2. Three friends want to share four chocolate bars among themselves so that they each get exactly the same amount of chocolate and no chocolate is left over. How can they do this?



Chris, a 5 year old Grade R child drew the solution above. This solution clearly shows that even very young children can solve problems that lead to fractions.

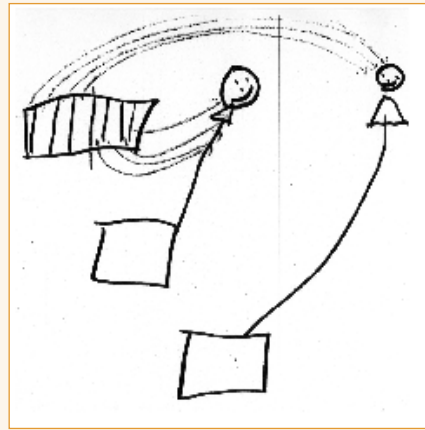

Ryan, a 5 year old Grade R child drew the solution above. Some children make more cuts than are necessary, although their solution is correct. They can be encouraged to make as few cuts (divisions) as possible.



Thokalele made a clear drawing, however some discussion about **equal** parts with the group may be necessary at this stage.

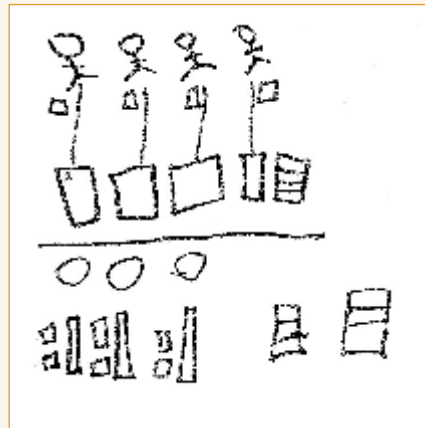

Mbali (who is working on a different problem) makes very clear drawings of $5 \div 4$ and $5 \div 3$. She shows a good understanding of the problems and is ready to learn the names of the different fractions.

Notice the following with respect to the initial problems:

- There are more objects (chocolate bars) than children. It is easier for children to share more than one object than to share a single object between a number of children.
- The second problem immediately introduces thirds. This is to prevent children from getting stuck on halves and quarters. In this context (cutting up real things) children find thirds and fifths no more difficult than halves and quarters.
- Allow children to make sense of the problems and to draw the solutions. Do not show them the fraction symbols. You should start using the fraction names only after the third or fourth similar problem.
- Discuss the different plans that children make with the group. Children may respond in many different ways, some with more potential for development than others. You should discuss the flaws in some plans with the group.

Once a child is comfortable with the idea of fractional parts of equal size, and knows how to name them, it is time to pose problems that involve the dividing up collections of objects into parts.

Benny has 10 sweets. He gives half of his sweets to Sandy. How many sweets does he give to Sandy?

Sandy's book has 12 pages. She has read 4 pages. She says: "I have read a third of my book." Is this true?

Some last practical suggestions for introducing fractions in the Foundation Phase

- When posing the introductory problems for the children, do not give them strips of paper or play dough models of the objects to be partitioned. If you partition a strip of paper into two equal pieces, **you** (as the adult teacher) may see halves, but the child simply sees two pieces of paper. The object to be shared must therefore be an identifiable whole, like a bar of chocolate or a slice of bread. Also, you need not physically cut up the object in front of the children – if they understand what the object is, you may put it away and they will draw their plans quite happily. Remember the drawings made by Chris and Ryan, both 5-year olds.
- Fractions like two-thirds, three-quarters, five-sixths (non-unitary fractions) should also be introduced through problems. If not, children will believe that it is only possible to one of a fractional part at a time, e.g. **one** third, **one** fifth.
- Use the fraction **names** (e.g. two thirds) almost from the beginning, but delay using the fraction symbols (e.g. $\frac{2}{3}$) for as long as possible (at least until Grade 3). If children are using the symbols by themselves but are doing so incorrectly (e.g. writing $\frac{2}{1}$ for a half) then the teacher will have to explain the symbols.
- Do not refer to numerator and denominator and/or attempt to define a fraction (e.g. two parts out of three parts; 2 divided by 3; and 2 over 3). Children can make sense of the meaning of fractions from problem that give rise to them.



Introduction

A pattern, in the most general sense, is a recurrence/repetition of events or objects. The power of patterns lies in the predictions they allow us to make.

We manage our lives through the expectation that the future is, in general, an extension of the past. It is this expectation of repetition that enables us to plan for the future.

Children have a natural tendency to look for patterns. They expect regularity in the world and this regularity helps them to make sense of their day to day experiences.

Mathematical patterns are, in general, no different to patterns in daily life. Patterns in mathematics enable us to see structure:

- in numbers;
- in mathematical operations;
- in geometric shapes and objects; and
- in data.

Pattern recognition enables us to predict:

- what will happen under certain circumstances: and
- what must happen for a desired outcome to occur.

Different kinds of patterns

Numerical patterns:

2; 4; 6; 8;;;;;;

2; 4; 8; 16;;;;;;

1; 2; 4; 2; 1; 2; 4; 2;;

Geometrical patterns:

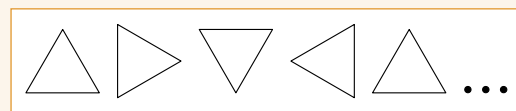

Mathematical patterns:

$8 \times 2 = 2 \times 8$ $8 + 2 = 2 + 8$
 BUT $8 \div 2 \neq 2 \div 8$ $8 - 2 \neq 2 - 8$

$(8 + 2) + 5 = 8 + (2 + 5)$
 BUT $(8 - 2) + 5 \neq 8 - (2 + 5)$

Illustration of the two kinds of predictions that we can make:

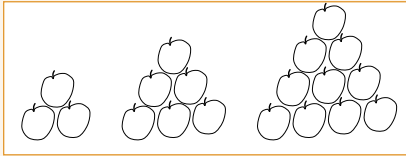

For the pattern above, determine:

- How many apples will be needed to make the sixth picture in the pattern?
- Which picture in the pattern can be made with 45 apples?

The study of patterns in the GET Band lays the foundation for the study of Algebra in the FET Band. It is very important that children are exposed to a range of different patterns from an early age and that they learn to look for patterns within patterns. For example:

- The numbers formed by skip counting in 2s, 5s, and 10 are all examples of number patterns:

2; 4; 6; 8; ; ;

5; 10; 15; 20; ; ;

10; 20; 30; 40; ; ;

These patterns have the underlying patterns (common properties) that:

- ▶ They are similar in that they are all formed by repeated addition; and
- ▶ They are different in that each of the patterns are formed by adding a different number to get from one term to the next.
- Doubling and halving are mathematical procedures

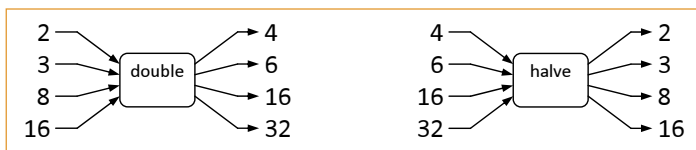

These procedures have the underlying patterns (common properties) that:

- ▶ They are similar in that they both involve 2; and
- ▶ They are different in that the one involves multiplication and the other involves division.
- Skip counting forwards and doubling have the underlying patterns that:
 - ▶ They are similar in that they result in increasing values; and

- ▶ They are different in that the rate of change is constant for skip counting forwards and exponential for doubling.
- Skip counting backwards and halving have the underlying patterns that:
 - ▶ They are similar in that they result in decreasing values; and
 - ▶ They are different in that the rate of change is constant for skip counting backwards and exponential for halving.
- When children sort shapes, shapes objects and data they are also concerned with the underlying pattern that:
 - ▶ Objects with similar properties are grouped together; and
 - ▶ Objects with differences are grouped separately.

Conceptual knowledge is really no more than:

- The recognition of patterns in and between situations; and
- The realisation of the value of these patterns in explaining and/or predicting and is developed through the reflection on and recognition of patterns and the realisation of the value of these patterns in explaining and/or predicting.

What we know

Patterns, in the Foundation Phase, provide support for the development of both a **strong sense of number** and of **conceptual knowledge**. Pattern activities should be used to:

- Develop advanced (systematic/clever) counting schemes;
 - ▶ Skip counting
 - ▶ Counting on
- Reveal properties of numbers (see the activities described in Unit 3);
 - ▶ Completing tens
 - ▶ Bridging tens
 - ▶ Adding and subtracting multiples of ten
- Reveal properties of operations including:
 - ▶ Addition and subtraction are inverse operations
 $4 + 2 = 6$ and $6 - 2 = 4$
 - ▶ Multiplication and division are inverse operations
 $4 \times 2 = 8$ and $8 \div 2 = 4$
 - ▶ Addition and multiplication are commutative
 $4 + 2 = 2 + 4$ and $4 \times 2 = 2 \times 4$
 - ▶ Addition and multiplication are associative
 $(4 + 2) + 5 = 4 + (2 + 5)$ and $(4 \times 2) \times 5 = 4 \times (2 \times 5)$
 - ▶ Multiplication is distributive over addition
 $2 \times (3 + 4) = 2 \times 3 + 2 \times 4$
- Identify common properties in shapes and objects as well as distinguishing between shapes and objects.

NOTE: There is no expectation that children in the Foundation Phase should know and use words like inverse, commutative, associative and distributive. What is expected is that they should be aware of these properties/patterns. This awareness is critical to the development of a strong sense of number.



The Foundation Phase Assessment Standards of Learning Outcome 2: Patterns, Functions and Algebra all belong to a single cluster – referred to as: recognising and describing patterns.

Table 2: Patterns, Functions and Algebra

The learner is able to recognise, describe and represent patterns and relationships, and solves problems using algebraic language and skills.				
	Grade R We know this when the learner:	Grade 1 We know this when the learner:	Grade 2 We know this when the learner:	Grade 3 We know this when the learner:
Recognising and describing patterns	<ul style="list-style-type: none"> Copies and extends simple patterns using physical objects and drawings e.g. using colours and shapes Creates their own patterns 	<ul style="list-style-type: none"> Copies and extends simple patterns using physical objects and drawings e.g. using colours and shapes Copies and extends simple number sequences to at least 100 Creates their own patterns 	<ul style="list-style-type: none"> Copies and extends simple patterns using physical objects and drawings Copies and extends simple number sequences to at least 200 Creates their own patterns 	<ul style="list-style-type: none"> Copies and extends simple patterns using physical objects and drawings Copies and extends simple number sequences to at least 1000 Creates their own patterns
		<ul style="list-style-type: none"> Describes observed patterns 	<ul style="list-style-type: none"> Describes observed patterns 	<ul style="list-style-type: none"> Describes observed patterns
		<ul style="list-style-type: none"> Identifies, describes and copies geometric patterns in natural and cultural artefacts of different cultures and times 	<ul style="list-style-type: none"> Identifies, describes and copies geometric patterns in natural and cultural artefacts of different cultures and times 	<ul style="list-style-type: none"> Identifies, describes and copies geometric patterns in natural and cultural artefacts of different cultures and times

Although pattern appears in CAPS as a separate content area: Patterns, Functions and Algebra, what should be clear from the discussion so far is that patterns:

- Underpin the development of number (Numbers, Operations and Relationships). In particular:
 - A strong sense of number;
 - The ability to calculate (operate) with numbers; and
 - The ability to recognise and describe relationships between numbers
- Are central to being able to sort geometric shapes and objects and to the study of their properties.
- Are what we are looking for when we study data. Data handling is nothing more than looking for trends (patterns) in existing data in order to be able to make predictions about the future.

Mathematics is the study of pattern. Looking for and using patterns should be integrated into all classroom activities in the Numeracy classroom.

Guidelines for practice

In order for children to be able to recognise patterns in general they need to start out by copying and extending existing patterns. The teacher's role is to:

- Provide the patterns that children must copy and extend; and
- Help children reflect on the activity – with particular focus on pattern recognition.

Remember it is only through active reflection that children will develop their **conceptual knowledge**.

To copy and extend patterns means being able to:

- Reproduce an existing pattern made of:
 - ▶ Shapes or objects;
 - ▶ Drawings and other representations; and
 - ▶ Numbers
- Add further elements to the pattern

When we ask children in Grades R and 1 to trace over a faint set of numbers and then to draw/write the same numbers another three or four times – we are asking them to copy a pattern and through doing so to learn how to write the numerals.

We are helping develop their **social knowledge** of writing and of writing numbers in particular through pattern recognition and copying.

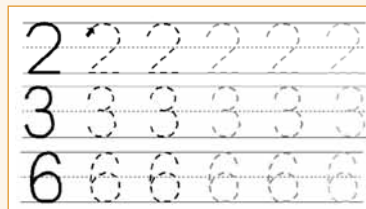

When we provide children with patterns such as those alongside and we ask them to extend the pattern then we are asking them in effect to think about **“what changes and what does not change as we go from one element of the pattern to the next”**.

A good introduction to this kind of activity involves collections of beads and a piece of string. A card with an illustration is provided and the child is told to string the beads onto the string provided as shown in the illustration.

The patterns illustrated so far are examples of **repeating patterns** – there is an element (consisting of one or more shapes/beads) that gets repeated.

Note to teachers: when developing activities such as these, it is important that you provide enough of the pattern so that the extension is obvious.

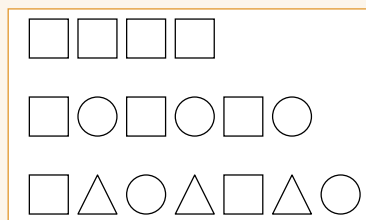

In addition to **repeating patterns** children should be exposed to other kinds of patterns such as **increasing (growing) patterns** and **decreasing (shrinking) patterns**. In both cases it is also important that they realise that patterns can increase by constant amounts and by changing amounts.

Throughout the pattern copying and extending activities described so far, it remains critical that children be given the opportunity to make the patterns using physical objects – firstly this will help develop their **physical knowledge** of patterns and secondly will help children to reflect on what it takes to extend/make the next element in the pattern and in so doing develop their **logico-mathematical/conceptual knowledge** of patterns.

Increasing pattern with a constant amount being added from one element to the next.

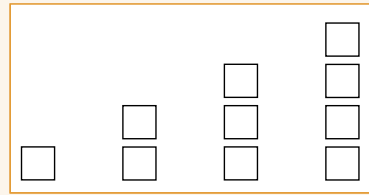

Increasing pattern with a changing amount being added from one element to the next.

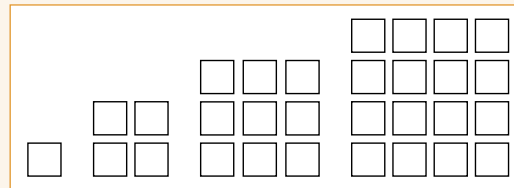

Decreasing pattern with a constant amount being subtracted from one element to the next.

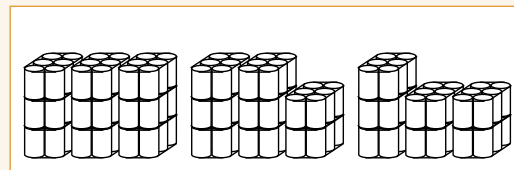

Decreasing pattern with a changing amount being subtracted from one element to the next.

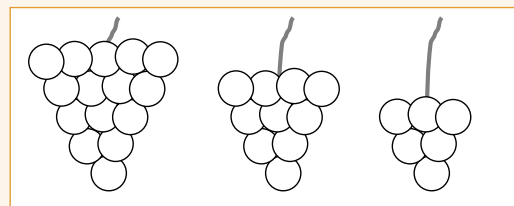

Patterns involving physical objects/drawings provide a natural transition introduction to **patterns involving numbers**.

In the blocks alongside the black counters are given and children are asked to place the light counters to complete the rows. In so doing they are exposed to the different number combinations that give 5.

The activity can be repeated for different size blocks from 2×2 to 10×10 and more.

	5		4 + 1
	4 + 1		3 + 2
	3 + 2		2 + 3
	2 + 3		1 + 4
	1 + 4		5

0	1	2	3	4	5	6	7	8	9
10	11	12	13	14	15	16	17	18	19
20	21	22	23	24	25	26	27	28	29
30	31	32	33	34	35	36	37	38	39
40	41	42	43	44	45	46	47	48	49
50	51	52	53	54	55	56	57	58	59
60	61	62	63	64	65	66	67	68	69
70	71	72	73	74	75	76	77	78	79
80	81	82	83	84	85	86	87	88	89
90	91	92	93	94	95	96	97	98	99

Numbers that are multiples of 3

0	1	2	3	4	5	6	7	8	9
10	11	12	13	14	15	16	17	18	19
20	21	22	23	24	25	26	27	28	29
30	31	32	33	34	35	36	37	38	39
40	41	42	43	44	45	46	47	48	49
50	51	52	53	54	55	56	57	58	59
60	61	62	63	64	65	66	67	68	69
70	71	72	73	74	75	76	77	78	79
80	81	82	83	84	85	86	87	88	89
90	91	92	93	94	95	96	97	98	99

Numbers that are multiples of 4

0	1	2	3	4	5	6	7	8	9
10	11	12	13	14	15	16	17	18	19
20	21	22	23	24	25	26	27	28	29
30	31	32	33	34	35	36	37	38	39
40	41	42	43	44	45	46	47	48	49
50	51	52	53	54	55	56	57	58	59
60	61	62	63	64	65	66	67	68	69
70	71	72	73	74	75	76	77	78	79
80	81	82	83	84	85	86	87	88	89
90	91	92	93	94	95	96	97	98	99

Numbers whose tens digit is one more than the units digit

Using blank modified hundred boards such as the ones above children place counters on the numbers that meet certain criteria. After placing the first few counters children should start to observe a pattern or patterns. These patterns will help them to anticipate the next block to be covered.

In completing this activity children are observing and describing patterns while at the same time developing their sense of number including the properties of numbers.

Activity: Patterns in circles

For each table and circle below:

- Complete the table
- Circle the last (or only) digit in each answer and write down the pattern of these numbers
- Connect the numbers of the pattern on the circle

	1	2	3	4	5	6	7	8	9	10	11	12
×2												

Pattern: _____

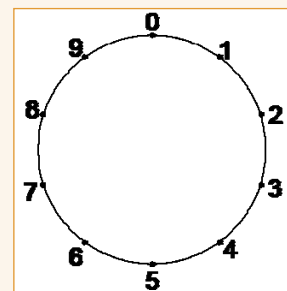

	1	2	3	4	5	6	7	8	9	10	11	12
×3												

Pattern: _____

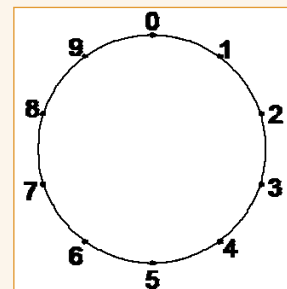

The *patterns in circles* activity above can be extended to include multiplication by 4, 5, 6 and so on. In completing the activity above, children will realise that certain tables give rise to the same patterns in the circles.

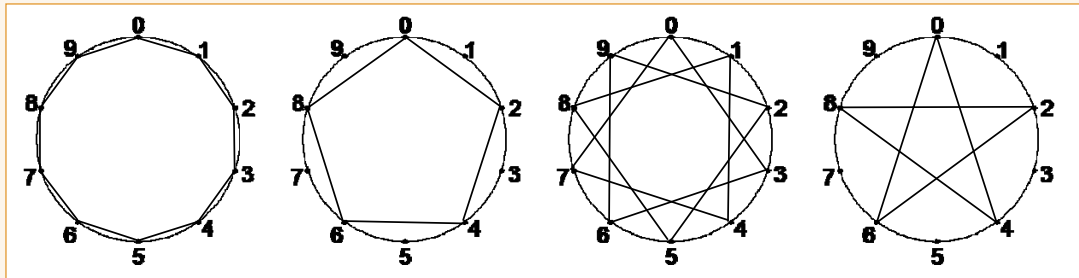

1 × and 9 ×
and
11 × and 19 × and ...

2 × and 8 ×
and
12 × and 18 × and ...

3 × and 7 ×
and
13 × and 17 × and ...

4 × and 6 ×
and
14 × and 16 × and ...

From patterns involving physical objects/drawings and number patterns the next natural transition is to move to **patterns involving numbers only**.

There are many ways in which such patterns are presented in class. In Unit 3 we introduced:

- Patterns
- Tables
- Flow diagrams;
- Number chains; and
- Problems.

Activities involving patterns, tables, flow diagrams and number chains can all be used to introduce numerical and mathematical patterns. After completing such activities and through reflecting on the activities (supported and encouraged by their teacher) children should recognise patterns. Through recognising patterns children will develop:

- their patterning skills;
- their number sense; and
- their conceptual knowledge.

Flow diagrams

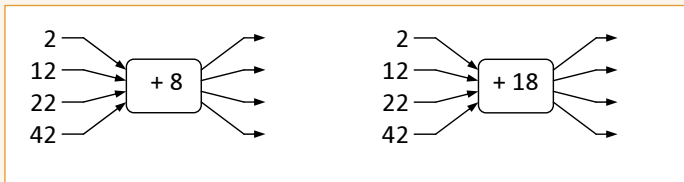

By completing these flow diagrams children could recognise the pattern that "whenever we add eight to a number ending in 2 we complete the 10", and that when we "add 18 to a number ending in 2 – it's like adding the eight to complete the 10 and adding another 10".

The pattern observed in completing the flow diagrams contributes to the development of a strong sense of **number**.

Tables

Number of tables	1	2	3	4	5	6
Number of legs	4	8	12			

Number of tables	1	2	3	4	5	6
Number of legs	5	10	15			

Number of tables	1	2	3	4	5	6
Number of legs	6	12	18			

Tables are important in activities used to develop patterning skills because they allow children to explain how they get their answers in at least two different ways.

In the three tables above, the values in the second row can be established by:

- Adding 4, 5, and 6 respectively to the numbers in the second row. In that way the table is simply completed by extending the pattern in the second row.

4; 8; 12; 16;;;
 5; 10; 15; 20;;;
 6; 12; 18; 24;;

Alternatively:

- Children can also be supported to see that the number in the second row is $4\times$, $5\times$ and $6\times$ the number in the first row respectively. And that there is no co-incidence in the fact that in the pattern where we are adding 4 we are also multiplying by 4 and the same for 5 and 6.

From a patterning perspective these children are observing both:

- A **recursive relationship**: adding a number to one term in the pattern to get the next; and
- A **functional relationship**: seeing a relationship between a term and its position in the sequence.

The relationship between the value of a term and its position in the pattern is the underpinning of the study of functions and algebra. By working with tables of values in the Foundation Phase we are laying the foundations for the later study of Algebra.

Tables II

Number	1	2	3	4	5	6
Number's friend 1	3	6	9			

Number	1	2	3	4	5	6
Number's friend 2	4	7	10			

Number	1	2	3	4	5	6
Number's friend 3	2	5	8			

These three tables that are related.

In all three tables we add three to get from one term in the second row to the next. However it is only in the first table the term in the second row is $3 \times$ the term in the first row.

By looking at the second rows of the three tables together we can see that in the second table we add 1 to the value in the first table and in the third table we subtract 1 from the value in the first table.

Looking for patterns within patterns

Number Chains

Through the use of the number chain on the right we can help children to see that the pattern: 8; 12; 16; 20 ... is generated by: "adding 4".

By contrast this pattern can help children to see what we have to "add 10" to get from one ten to the next.

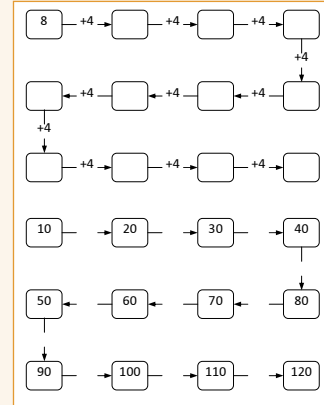

The key point that the discussion so far has tried to convey is that simply writing down the next three terms in the pattern:

4 6 8

is reasonably meaningless. Although this may appear to be an interpretation of the Assessment Standard: "copying and extending patterns", it is little more than a game of "guess the next value".

By contrast when we design pattern completion and extension activities with intent we can use the same activities to support the development of:

- A strong sense of number;
- The ability to calculate (operate) with numbers; and
- The ability to recognise and describe relationships between numbers.

Through reflection – facilitated by the teacher – children learn to use patterns to help them recall, order and extend their understanding and use of number and number relationships.

From Grade R to Grade 3, patterns and patterning play a critical role in revealing structure:

- In numbers;
- In mathematical operations;
- In geometric shapes and objects; and
- In data.

Patterns and patterning support the development of **logico-mathematical/conceptual knowledge**.

There is no significant difference between the Assessment Standards for each Grade in the Foundation Phase and this is quite simply because the progression from one year to the next lies in the increasing number range used in the patterns and the increasing complexity of the patterns.

For example if we refer back to the repeating/bead patterns described at the start of the unit. We could imagine Grade R's making the bead pattern by simply copying it and the pattern they are copying involving only one or at most two shapes. By Grade 3 the same activity could involve several shapes and colours as well.

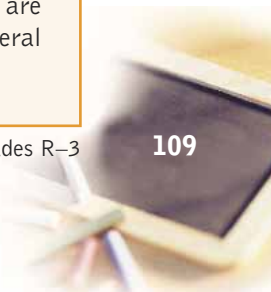

Activity

Use your peg board and pegs to make the picture:

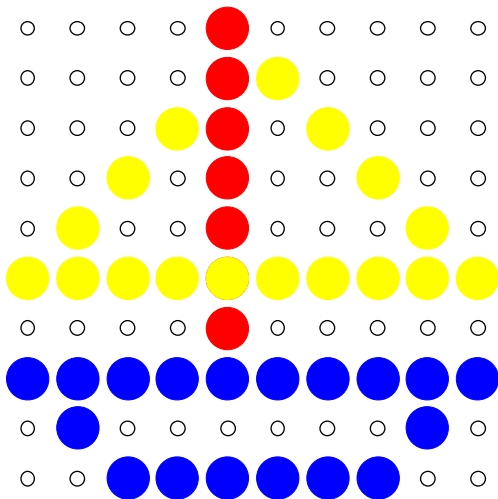

Activity

Use your beads to copy and continue these patterns:

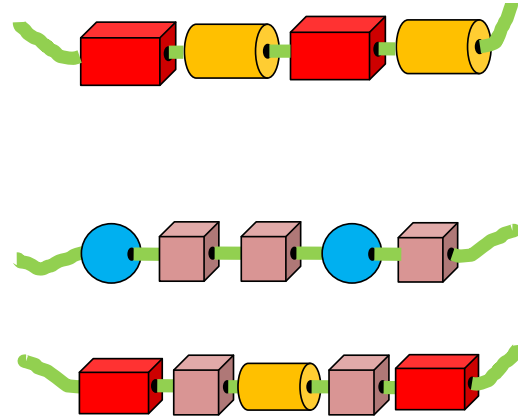

Use your beads to make a repeating pattern of your own.

Activity

These are examples of border patterns



This is a border pattern made of two shapes:

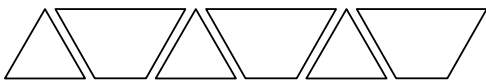

Choose any two of the shapes below and create your own border pattern:

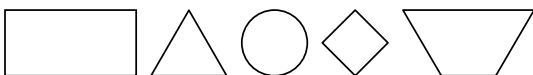

Activity

This house has been decorated with a border pattern.



Cut out the shapes below and use them to create a border pattern like the one on the house

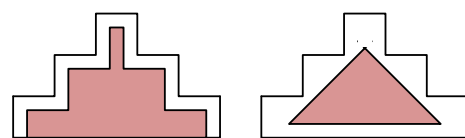

Activity

These are number patterns. Can you complete them?

1 ; 2 ; 3 ; ; ; ; ; ; ;

10 ; 9 ; 8 ; ; ; ; ; ; ;

1 ; 2 ; 3 ; 2 ; 1 ; 2 ; 3 ; ; ; ;

1 ; 2 ; 4 ; 8 ; ; ; ; ; ;

2 ; 4 ; 6 ; 8 ; ; ; ; ; ;

3 ; 5 ; 7 ; 9 ; ; ; ; ; ;

Can you make your own number patterns?

..... ; ; ; ; ; ; ; ; ;

..... ; ; ; ; ; ; ; ; ;

Activity

Complete each of the tables:

Faces	1	2	3	4	5	6	7
Eyes	2						

Hands	1	2	3	4	5	6	7
Fingers	5						

Hands	8	9	10	11	12	13	14
Fingers							

People	1	2	3	4	5	6	7
Fingers	10						

People	8	9	10	11	12	13	14
Fingers							

Dogs	1	2	3	4	5	6	7
Feet	4						

Activity

Samantha and Desiree are going to save money.

Samantha starts with an empty piggy bank and puts in R10 every month.

Desiree has a piggy bank with R10 in it. She is going to put in R8 every month.

Complete the following table:

Number of months	1	2	3	4	5	6	7
Samantha's money	10						
Desiree's money	18						

Who has the most money in her piggy bank after two months?

Who has the most money after 6 months?

How much money will each girl have after one year (12 months)?

Activity

Complete the following number chain.

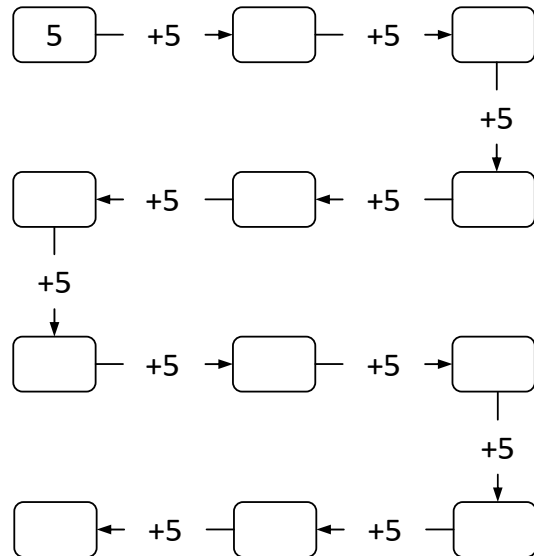

Introduction

Geometry is a branch of mathematics concerned with understanding the spatial world. It is concerned with:

- Shape – the way things look
- Structure – the way things are put together
- Location – where we are relative to other things; and
- Movement – getting from one location to another.

The development of spatial reasoning not only contributes to the development of Numeracy/Mathematics in general but also to an appreciation of aesthetics; an understanding of science; and the ability to reason in a deductive manner.

The study of space and shape in the Foundation Phase provides children with an appreciation of their physical world and the language to describe it.

What we know

Our understanding of how children develop spatial sense (geometric thinking) has been significantly influenced by the work of Pierre van Hiele which is described in Unit 2. There are two key aspects of van Hiele's work that are of significance.

- Van Hiele described the levels or stages of geometric development that individuals progress through as they develop spatial sense (geometric thinking).
 - ▶ visualisation;
 - ▶ analysis;
 - ▶ abstraction;
 - ▶ deduction; and
 - ▶ rigour.
- Van Hiele also described *phases of learning* that support this development. The phases describe the different kinds of tasks which together make up lessons on space and shape. In terms of the Foundation Phase the most important of these phases are:
 - ▶ free-play (inquiry phase);
 - ▶ focused play; and
 - ▶ explicitation.

Knowledge of the van Hiele levels allows teachers to describe the extent of each child's development with respect to geometric thinking in much the same way that the levels of number concept development allow us to describe the extent of each child's sense of numbers.



Free play (inquiry phase): During periods of “free-play” children are provided with materials and the opportunity to “play” with them.

- By working with (playing with) materials children develop **physical knowledge** of shapes and objects (figures and solids).
- As a consequence of being allowed to “play” with materials guided only by their imagination and inventiveness, children start to develop a sense of the properties of the materials with which they are busy.
- Throughout times of “free play” children develop their **visualisation** skills – the ability to recognise shapes and objects (figures and solids), to sort them into groups with similar attributes and to see similarities and differences between shapes and objects (figures and solids).

During periods of “free play” children are literally provided with concrete materials (apparatus) such as:

- Building blocks;
- Tiles (Tangrams and other tiles); and
- Shapes and objects (also known as figures and solids).

To make or invent new shapes and objects (figures and solids) through building (joining, stacking etc).

What is important in this lesson phase is that children are encouraged to describe what they have made and how they did so in their own language. **Discussion** causes **reflection** and reflection contributes to the development of **conceptual knowledge**.

Focused play: During periods of “focused play” children continue to work with the same materials (apparatus) that they use during “free play”. The difference is that: rather than allowing the children to make/invent their own new shapes and objects (figures and solids), the teacher now guides the activity by setting challenges/problems.

For example the teacher may use a set of blocks to make some arrangement and ask the children:

- To make the same arrangement; or
- To make an enlargement or reduction of the arrangement.

In order to meet the challenge or solve the problem the child is forced to think about the attributes/properties of the geometrical shapes and objects with which they are working.

Questions such as:

- “How can I make this piece fit here?” or
- “What do I need to complete this arrangement?” or
- “Is there a piece with a longer side or a greater height?” etc

help children to develop their **logico mathematical (conceptual) knowledge** of the shapes and objects (figures and solids) with which they are working.

Both free- and focused play contribute to children developing intuitive understandings of how shapes and objects are the same and/or different. They begin to realise that properties such as the lengths of the sides/edges, the angle-size of vertices and nature of surfaces all define the shape or object with which they are working.

As a result of focused play type activities children are, in terms of the van Hiele levels of geometric development, moving to the **analysis** stage of development – starting to recognise properties of the shapes and objects (figures and solids) with which they are working, although at this stage they may not see any relationships between these properties.

Explicitation: In addition to periods of “free play” and “focused play” teachers also need to provide time to introduce children to the vocabulary – the names – associated with the shapes and objects that they have used in the activities that they have worked on. That is, the teacher needs to introduce the children to the **social knowledge** associated with the shapes and objects.

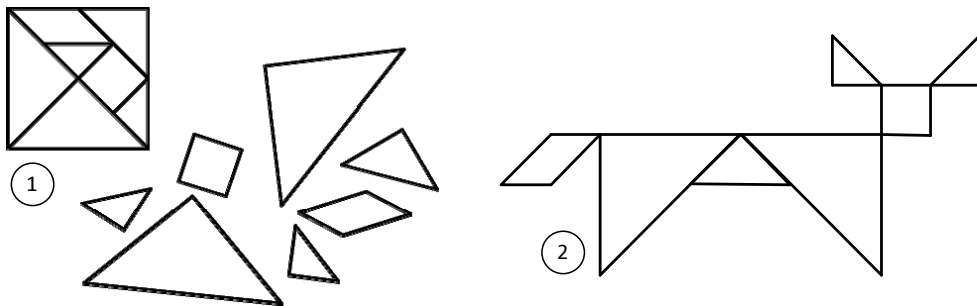

The van Hiele phases of a lesson explained in terms of tangram pieces

When the teacher gives children a set of tangram pieces (1) and invites them to use the pieces to make whatever they can or want to, she has created an opportunity for **free play**.

When the teacher supplies the children with an outline of a figure that she wants the children to make using their tangram pieces (2), she is creating a opportunity for **focused play**. The child must match the pieces to the spaces and in doing so is continuously thinking about the properties of the shapes that he/she is working with – continuously developing their **conceptual knowledge** of the shapes.

As the teacher introduces the children to the vocabulary (names) associated with the pieces of the puzzle, she is busy with **explicitation**.

When the teacher asks the child to make the figure (of the cat) (3) – without showing the individual pieces, the children are still busy with **focused play**, however, the task is now a lot more difficult and relies on them having a better sense of the properties of the pieces and the relationships between the pieces.

Geometric thinking in the Foundation Phase is developed as a result of children:

- Working (playing) with concrete apparatus on a frequent basis engaged in at least two different kinds of activities:
 - ▶ Free play – time to play with the apparatus guided by their own curiosity and interest; and

- ▶ Focused play – time to use the apparatus to complete specific tasks – that is to **solve problems**.

Geometric thinking **is not developed** as the result of lessons in which the teacher draws different shapes and objects on a chalkboard and asking children to recite the names.

Such teaching is not just meaningless but it also contributes to so many of the limiting constructions (impressions that children have). For example children who are only exposed to the different shapes and objects (figures and solids) through pictures on the board and the reciting of their names develop the beliefs that:

- Triangles are always equilateral/isosceles, and have a base that is parallel to the horizon,
- Squares and rectangles are unrelated – as opposed to recognising that squares are special rectangles, and
- Rectangles are red and triangles are blue.

Children need to work with and to handle (touch) many triangles of different kinds and sizes before they can begin to see triangle as a label for a collection of shapes (figures) with certain properties (three sides and three vertices).

Space and Shape (Geometry) for the Foundation Phase support the teaching approach that has been described above – they have been developed in line with the insights into the development of geometric thinking as described by van Hiele.

Space and Shape can be clustered into three main groups with the first of these groups being further subdivided as follows:

- Shapes and objects (figures and solids)
 - ▶ Shapes and objects
 - ▶ Properties
 - ▶ Making
- Transformations
- Position

The diagrammatic representation shows how Shape and Space must be taught.

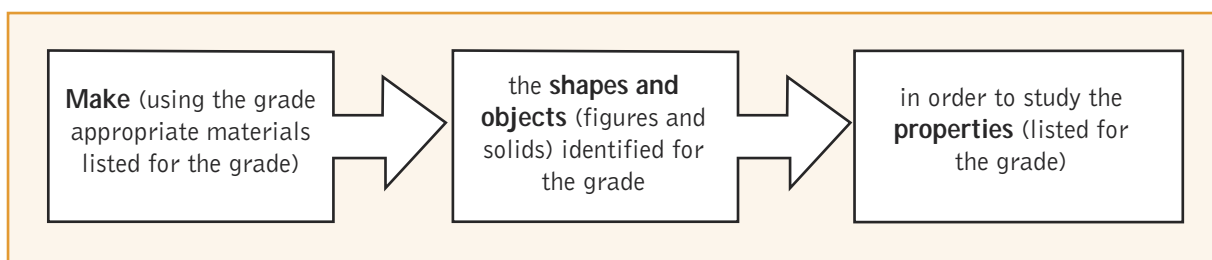

The learner is able to describe and represent characteristics and relationships between 2-D shapes and 3-D objects in a variety of orientations and positions					
		Grade R We know this when the learner:	Grade 1 We know this when the learner:	Grade 2 We know this when the learner:	Grade 3 We know this when the learner:
Shapes and Objects	Shapes and Objects	<ul style="list-style-type: none"> Recognises, identifies and names 3-D objects in the classroom and in pictures including: <ul style="list-style-type: none"> Boxes (prisms) Balls (spheres) 	<ul style="list-style-type: none"> Recognises, identifies and names 2-D shapes and 3-D objects in the classroom and in pictures including: <ul style="list-style-type: none"> Boxes (prisms) and balls (spheres) Triangles and rectangles Circles 	<ul style="list-style-type: none"> Recognises, identifies and names 2-D shapes and 3-D objects in the school environment and in pictures including: <ul style="list-style-type: none"> Boxes (prisms), balls (spheres) and cylinders Triangles, squares and rectangles Circles 	<ul style="list-style-type: none"> Recognises, identifies and names 2-D shapes and 3-D objects in the environment and in pictures including: <ul style="list-style-type: none"> Boxes (prisms), balls (spheres) and cylinders Cones and pyramids Triangles, squares and rectangles Circles
	Properties	<ul style="list-style-type: none"> Describes, sorts and compares physical 3-D objects according to: <ul style="list-style-type: none"> Size Objects that roll Objects that slide 	<ul style="list-style-type: none"> Describes, sorts and compares physical 2-D shapes and 3-D objects according to: <ul style="list-style-type: none"> Size Objects that roll or slide Shapes that have straight or round edges 	<ul style="list-style-type: none"> Describes, sorts and compares 2-D shapes and 3-D objects in pictures and the environment according to: <ul style="list-style-type: none"> Size Objects that roll or slide Shapes that have straight or round edges 	<ul style="list-style-type: none"> Describes, sorts and compares 2-D shapes and 3-D objects in pictures and the environment including: <ul style="list-style-type: none"> 2-D shapes in or on the faces of 3-D objects Flat/straight and curved/round surfaces and edges
	Making	<ul style="list-style-type: none"> Builds 3-D objects using concrete materials (e.g. building blocks) 	<ul style="list-style-type: none"> Observes and builds given 3-D objects using concrete materials (e.g. building blocks and constructions sets) 	<ul style="list-style-type: none"> Observes and creates given 2-D shapes and 3-D objects using concrete materials (e.g. building blocks, construction sets and cut-out 2-D shapes) 	<ul style="list-style-type: none"> Observes and creates given and described 2-D shapes and 3-D objects using concrete materials (e.g. building blocks, construction sets, cut-out 2-D shapes, clay and drinking straws)

The learner is able to describe and represent characteristics and relationships between 2-D shapes and 3-D objects in a variety of orientations and positions					
Grade R		Grade 1		Grade 2	Grade 3
We know this when the learner:		We know this when the learner:		We know this when the learner:	We know this when the learner:
Transformations	<ul style="list-style-type: none"> Recognises symmetry in themselves and their environment (with focus on front and back) 	<ul style="list-style-type: none"> Recognises symmetry in themselves and their environment (with focus on left, right, front and back) 	<ul style="list-style-type: none"> Recognises symmetry in 2-D shapes and 3-D objects 	<ul style="list-style-type: none"> Determines lines of symmetry in 2-D shapes using paper folding and reflection 	
	<ul style="list-style-type: none"> Describes one 3-D object in relation to another (e.g. in front of or behind) 	<ul style="list-style-type: none"> Describes one 3-D object in relation to another (e.g. in front of or behind) 	<ul style="list-style-type: none"> Recognises 3-D objects from different positions 	<ul style="list-style-type: none"> Recognises and describes 3-D objects from different positions 	
Position	<ul style="list-style-type: none"> Follows directions (alone and/or as a member of a group or team) to move or place him/herself within the classroom (e.g. at the front or at the back) 	<ul style="list-style-type: none"> Follows directions (alone and/or as a member of a group or team) to move or place him/herself within the classroom or 3-D objects in relation to each other 	<ul style="list-style-type: none"> Positions him/herself within the classroom or 3-D objects in relation to each other 	<ul style="list-style-type: none"> Reads interprets and draws informal maps of the school environment or of an arrangement of 3-D objects and locates objects on the map. 	
			<ul style="list-style-type: none"> Describes positional relationships (alone and/or as a member of a group or team) between 3-D objects or him/herself and a peer 	<ul style="list-style-type: none"> Describes positional relationships (alone and/or as a member of a group or team) between 3-D objects or him/herself and a peer 	

Children should be given the opportunity to **play** both generally (*free-play*) and purposefully (**focused play**) with a **wide range of materials** in order to **make (build) shapes and objects (figures and solids)**. Through play they come to describe, sort and compare the geometric figures and solids – and in so doing they learn about their properties: their similarities and their differences.

With respect to the ideas raised in this handbook such as Piaget’s kinds of knowledge and van Hiele’s phases of teaching and learning, the above remarks can be summarised as follows:

Children can come to an awareness of the properties of shapes and objects through the free- and focused play opportunities in ways that are far more meaningful than when these properties are taught as lists that must be memorized (i.e. as social knowledge)

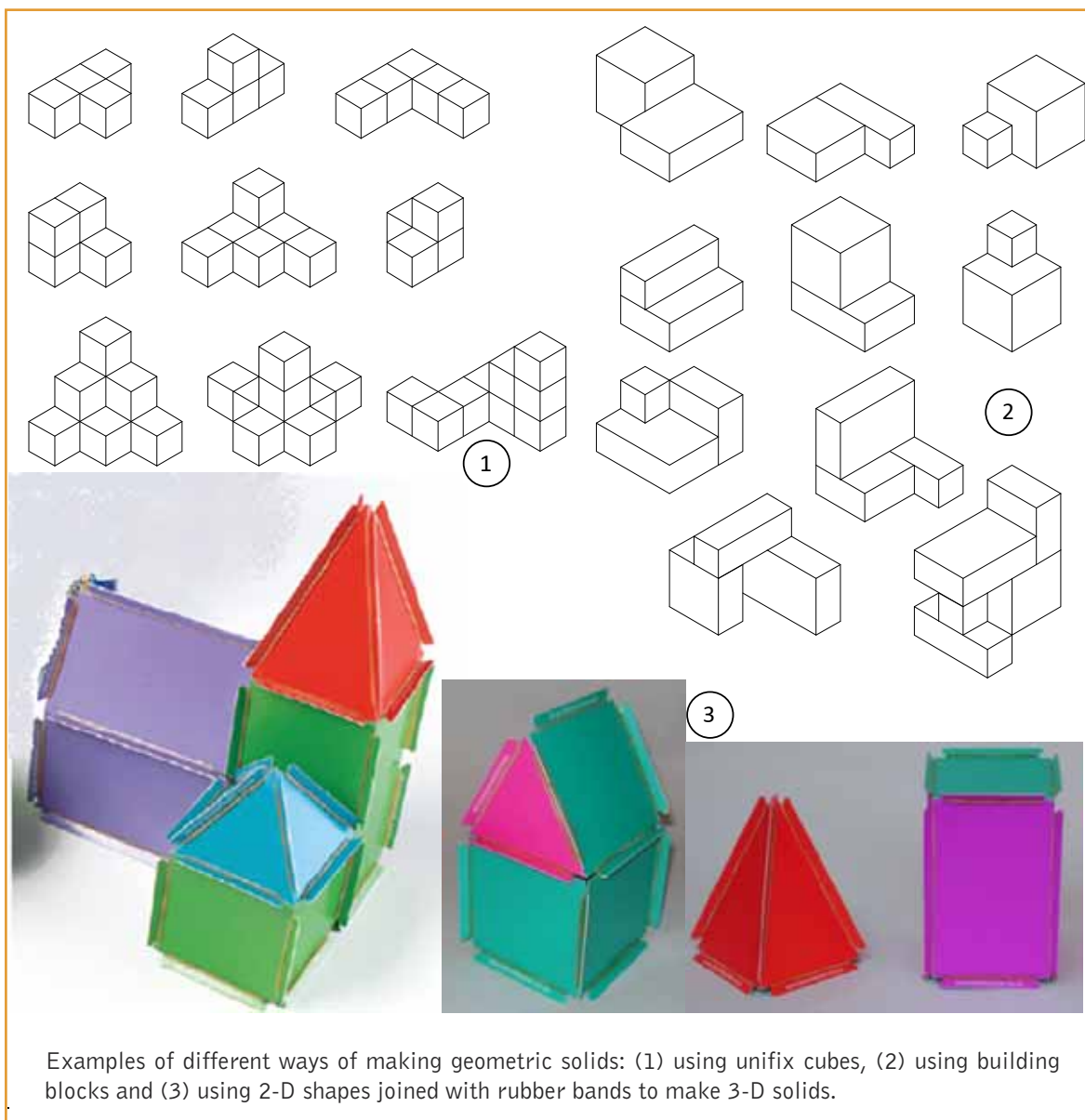
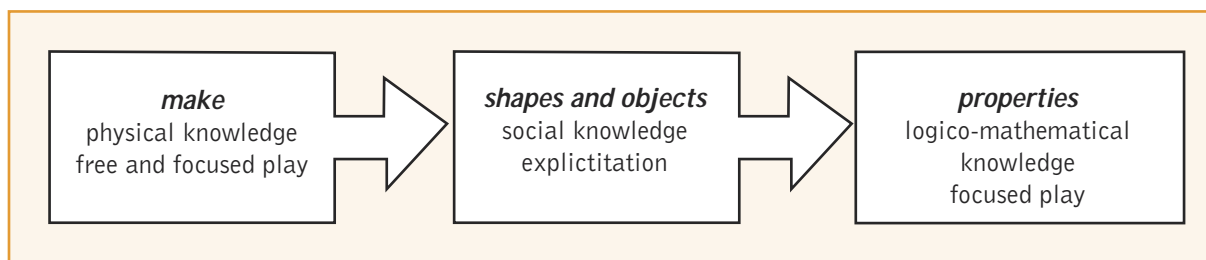

The **transformations** cluster should be seen as laying the foundations for an understanding of the different actions that can be performed on shapes and objects that preserve the properties of the shapes and objects.

In the Intermediate Phase these actions are studied in greater detail and given the names:

- Slide (translation)
- Turn (rotation)
- Flip (reflection)

The focus in the Foundation Phase is on developing a sense of symmetry – reflection about a line and/or rotation about a point.

Children should develop the sense that when something is symmetrical then there is “a sameness” about the things being compared. It is important throughout that children realise that we need a way of showing (convincing ourselves and others) that things are the same. It is not enough to say that things look the same.

In the case of line symmetrical drawings this sameness can be shown by folding along a line of symmetry. In the case of rotational symmetry this sameness can be show by turning around a point.

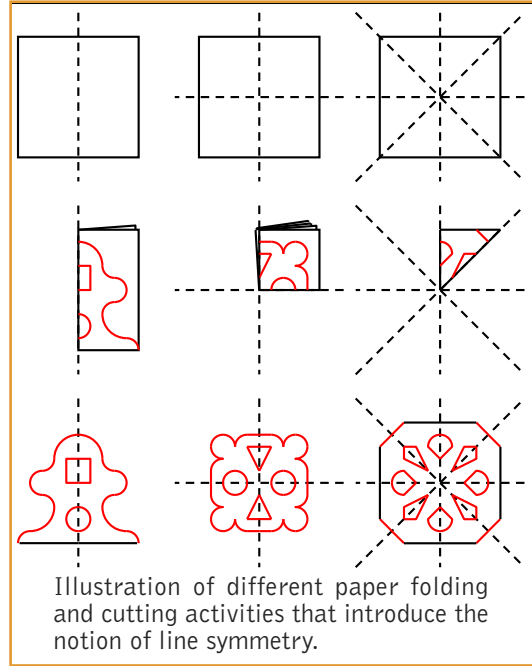

In addition to realising that line symmetrical figures can be “folded to lie on themselves,” children should also be supported in coming to realise that some of the elements of the figure are closer to the “fold” and others further away and that this is true for the matching components.

With respect to the **position** cluster the focus in the foundation phase is on laying the foundation for an understanding of:

- Reference frames – ways of describing the position of an object (e.g. grids and coordinate systems)
- Relative positions – ways of describing positions of two or more objects with respect to each other (e.g. compass directions and distance), and
- Movement – ways of describing movement between one place and the next.

In the Foundation Phase the focus should be on developing a sense of relative position and the associated vocabulary:

- On top and below,

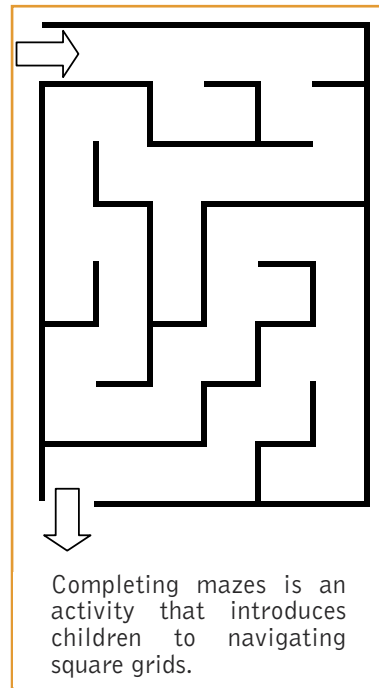

- In front and behind,
- To the left of and to the right of,
- Between and so on.

This vocabulary is not only important in its own right but is also important as children describe their actions in the **making** and **position** Assessment Standards of the **shapes** and **objects** cluster.

The position that refers to “recognising and describing objects from different positions” draws attention to the intuitive yet abstract notion that even though an object, say a cube may “look different from different positions” it remains a cube and its properties do not change.

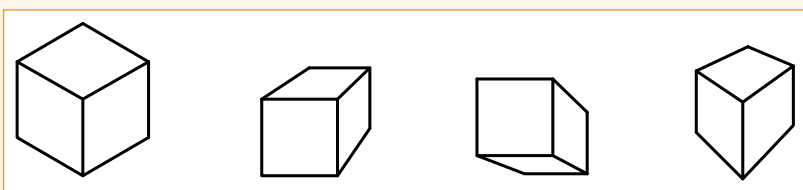

Consider the different representations of the cube above in each one a different view (perspective) of the cube is given.

Despite the different impressions that we get of the cube by looking at it from different positions, it should be clear that the cube remains a cube with:

- Six faces, each of which is a square;
- Eight vertices; and
- Twelve edges, each with the same length (many of which are hidden in each representation).

In order to develop this notion children need a lot of experience with holding objects (solids) in different positions and matching the positions to pictures of the objects.

Guidelines for practice

The most important message to take from the earlier remarks in this unit is that children in the Foundation Phase need to have **extensive opportunities to play/work with concrete apparatus**.

Each Foundation Phase classroom must have large collections of shapes and objects that children can play/work with. At a minimum there should be:

- Building blocks – with a large number of different shaped objects (solids) preferably in a range of different colours.



- Unifix-type cubes – these cubes can be joined together to aid in the making of different objects



- Tangram type puzzle pieces – these pieces can be rearranged to make a wide range of different shapes and in doing so children learn to identify and match equal properties

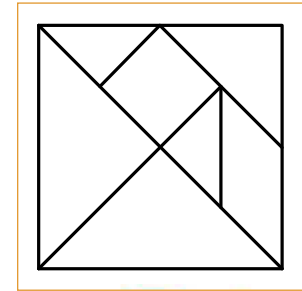

- Collections of different shapes (circles; triangles; squares; rectangles; hexagons etc.) in a range of sizes, colours and thicknesses – sets of these shapes are sometimes referred to as attribute blocks

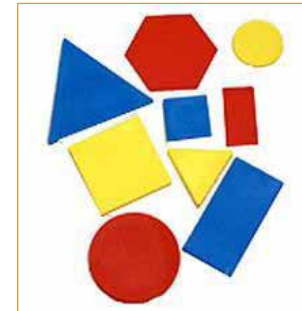

- Construction kits of different kinds – in particular kits that allow children to make 3-D objects (solids) from 2-D shapes (figures). While some kits allow these pieces to be clipped together others use rubber bands to hold the pieces together



- Examples of 3-D objects (solids) found in the home such as boxes, balls, cones and cylinders.



There should be at least three different kinds of classroom activities involving the **shapes and objects** (figures and solids) listed above:

- Opportunities for children to play freely with the apparatus;
- Opportunities for children to use the apparatus to complete tasks set by the teacher – that is: to solve problems; and
- Opportunities for children to be introduced to the names of the different shapes and objects.

Each of these is described in some detail below.

- **Opportunities for children to play freely with the apparatus.** Throughout the Foundation Phase children should be given the time to play with, **make** and invent using the concrete apparatus. Grade Rs and 1s should be given even more time for this than Grade 2s and 3s.

During periods of free play, children’s actions should be guided by their imaginations.

What is critical is that each child must be given the time to describe what they have made in their own language – it is the teacher’s role to encourage and manage this discussion/reflection.

By playing with the apparatus to **make** figures and objects, children are developing both their:

- **physical knowledge** of the shapes and objects through touch; and
- **conceptual knowledge** as they become aware of the properties of the shapes and objects as a result of joining them to make new shapes and objects.

- **Opportunities for children to use the apparatus to complete tasks set by the teacher** – that is: to **solve problems**.

The tasks set by the teacher will vary but could include:

- ▶ **Sorting the shapes and objects:** Children should be given the opportunity to sort the shapes and objects both according to their own criteria, which they must explain to the teacher and to their class mates, as well as according to criteria set by the teachers (and listed in the curriculum).

Through sorting the shapes and objects, children become aware of the properties of the shapes and objects – they are developing their **logico-mathematical (conceptual) knowledge** of the shapes and objects.

<ul style="list-style-type: none"> • Describes, sorts and compares physical 3-D objects according to: <ul style="list-style-type: none"> ▶ Size ▶ Objects that roll ▶ Objects that slide 	<ul style="list-style-type: none"> • Describes, sorts and compares physical 2-D shapes and 3-D objects according to: <ul style="list-style-type: none"> ▶ Size ▶ Objects that roll or slide 	<ul style="list-style-type: none"> • Describes, sorts and compares 2-D shapes and 3-D objects in pictures and the environment according to: <ul style="list-style-type: none"> ▶ Size 	<ul style="list-style-type: none"> • Describes, sorts and compares 2-D shapes and 3-D objects in pictures and the environment including: <ul style="list-style-type: none"> ▶ 2-D shapes in or on the faces of 3-D objects
---	---	--	---

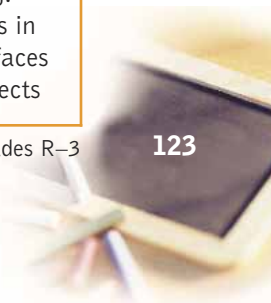

	<ul style="list-style-type: none"> ▶ Shapes that have straight or round edges 	<ul style="list-style-type: none"> ▶ Objects that roll or slide ▶ Shapes that have straight or round edges 	<ul style="list-style-type: none"> ▶ Flat/straight and curved/round surfaces and edges
--	--	--	---

- ▶ **Making shapes and objects according to instructions provided by the teacher:** Most of the apparatus described above come with cards that make suggestions of things that can be made using the apparatus.

Teachers should supply the children with the apparatus and one or more cards at a time and ask the children to make the shapes or objects illustrated on the card.



Note: There are typically two kinds of cards (as discussed earlier) – cards that show the pieces to be used and cards that show the outlines of the shape to be made but not the pieces to be used. The first kind of card is less demanding while the second is more demanding and develops a greater sense of the properties of the shapes and their interrelationships.

Children completing tasks set by the teacher is an excellent example of what van Hiele referred to as **focused play** – the purpose of these activities is once more to assist children in developing their **conceptual knowledge** of the shapes and objects.

The role of the teacher, in addition to supplying the instructions (on cards if possible), is to discuss with the children whether or not they have achieved the objectives – this discussion includes the language of **position** – on top, below, in front, behind, to the left of and to the right of, between and so on.

Where there are no cards supplied with the apparatus, the teacher can make her own – either by making actual cards or simply by making an arrangement using the shapes and objects and asking the children to copy her arrangement.

An aspect of the discussion that is quite critical here (especially with the 3-D arrangements), is that children come to realise that the arrangement may look different when looked at from different positions – going so far as to realise that some of the elements may not even be visible from some points of view.



Two different activity cards working with tangram pieces – both to be used during focused play activities.

With both cards, the child must make the shape using their tangram pieces. In the case of the candle the pieces are shown whereas in the case of the runner the pieces are not shown.

Children would first be asked to make the shapes with the lines showing and with time as they gain confidence so they can be asked to make the shapes without lines.

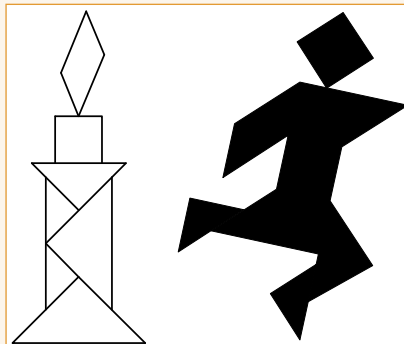

Recording, through drawing, the shapes and objects created is another useful activity that helps children develop their sense of shape and space.

- **Opportunities for children to be introduced to the names of the different shapes and objects** – that is, for children to be introduced to the vocabulary (the **social knowledge**), associated with the shapes and objects (including the names of the shapes and objects as well as the names for elements of the shapes and objects – edges, corners etc).

It should be clear that the Assessment Standards of the **position cluster** are dealt with:

- Quite naturally as the teacher and children discuss the things that they have made; and
- On an ongoing basis in day to day discussion as part of every lesson: stand behind your desk, place your chair on top on the table, put your book on top of the table etc.
- Maps of the classroom, school and school grounds should also be used to develop children's sense of position.

NOTE: while it should be clear that children can complete the kinds of activities described above (playing freely and completing tasks set by the teacher) without knowing any of the names of the shapes and objects, it becomes useful for children to know the names so that they can more easily discuss what they are doing. The point is that the vocabulary should be introduced during the discussion associated with the activities rather than as a separate activity all on its own and/or as a lesson on naming shapes and objects and their properties before any free or focused play takes place.

Progression with respect to Space and Shape (Geometry) from one Grade to the next is simply in terms of the complexity of the activities that the children perform with the apparatus. As they progress from Grade to Grade and gain confidence more pieces are used, more complex demands are set and more sophisticated discussion is used to describe what they have done.

Many of the cards that make suggestions on what to do with, for example the attribute blocks include activities that involve children **completing patterns/sequences** and as such these activities can also be integrated with the work.

Activity

Find your way through the maze:

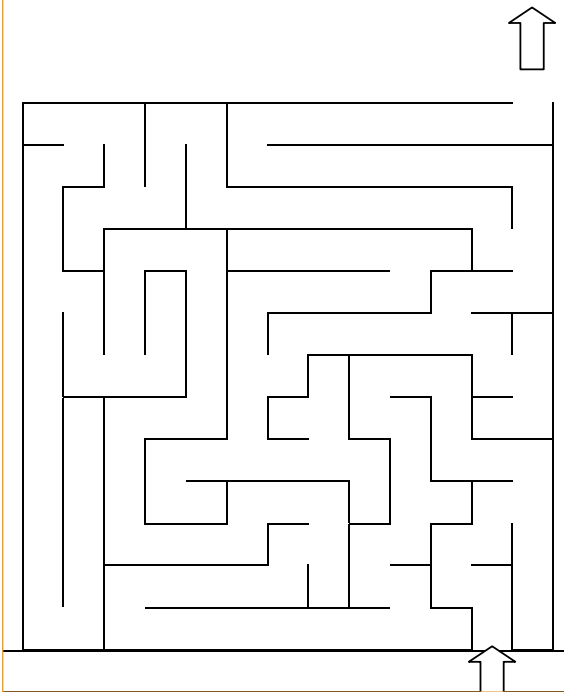

Activity

Use your shapes to make these pictures:

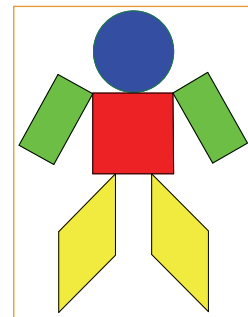
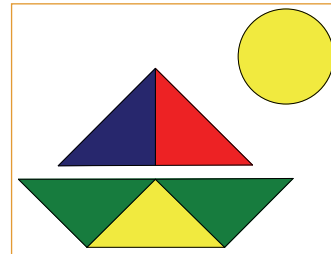

Activity

Use your shapes to make these pictures:

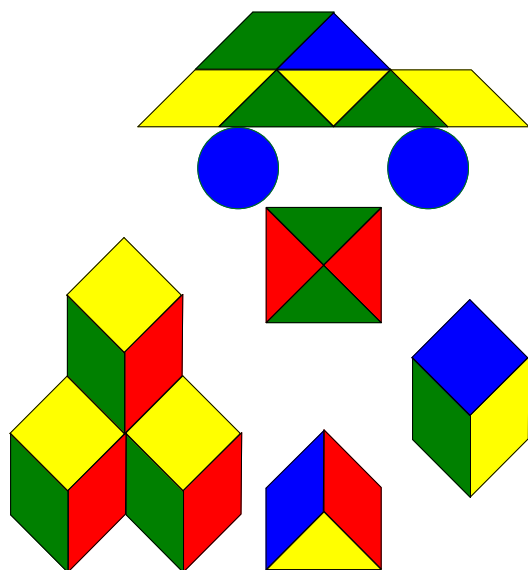

Activity

Use your shapes to make these pictures:

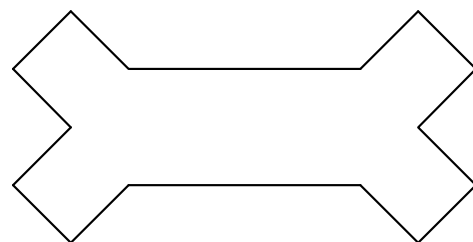
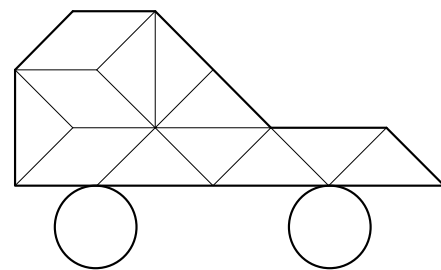

Introduction

Measuring is the process of comparing the size (muchness) of some property of an object or event:

- Either relative to the same property of another object or event;
- Or to some **standard unit of measure**.

Measurements that can be determined include (among many others):

- Length (mm, cm, m, km, inches, feet, yards and miles);
- Area (cm², m², acres, hectares);
- Weight (kg, pounds, tonnes);
- Volume (m³; litres; kilolitres, ounces, quarts and gallons);
- Temperature (degrees Celcius and degrees Fahrenheit);
- Speed (m/s, km/h, miles/hour); and
- Time (seconds, minutes, hours, days, weeks, months and years etc.).

What we often take for granted is the existence of the standard units for each of these measurements (listed above).

What we also take for granted is the existence of conversion rates that can be used to convert between the different units.

The history of measurement and of units is, however, not nearly as easy or “taken for granted”.

Measurement has evolved over time as a consequence of the desire of people to take control over and to structure their environment. People want to be able to compare: which is longer and which is shorter; which is heavier and which is lighter; which is hotter and which is colder – and for each of these comparisons it is easy – you consider the two objects or events and “place them in a scale” – you literally compare them and the question is answered. This one on one comparison is however limited to the comparison of the two objects or events in question.



In order to make more general comparisons people started making comparisons not between two particular objects or events but between objects or events and some “standard”. For example people used hand spans and arm lengths, paces and longer but still informal measurements. Of course one person’s hand span is different to another person’s and so with time more standard or comparable units were introduced. The purpose of these remarks is to make the point that the taken for granted units we use today to high degrees of accuracy/precision are inventions of people over time.

What is important is that children develop the insight that measuring:

- Is about comparing and quantifying; and
- Involves units/measurements that allow us to quantify and compare in convenient and reliable ways.

What we know

The challenge in teaching is to create an environment in which children experience the evolution of measuring in an informal manner so that they can understand units as arbitrary but convenient.

Measurement in the Foundation Phase can be clustered into two main clusters: **time** and **measuring**.

The learner is able to use appropriate measuring units, instruments and formulae in a variety of contexts				
	Grade R We know this when the learner:	Grade 1 We know this when the learner:	Grade 2 We know this when the learner:	Grade 3 We know this when the learner:
Time			<ul style="list-style-type: none"> • Reads analogue and digital clock time in hours and minutes 	<ul style="list-style-type: none"> • Reads and writes analogue and digital clock time in terms of hours, half-hours, quarters of an hour and minutes
	<ul style="list-style-type: none"> • Describes the time of day in terms of day or night 	<ul style="list-style-type: none"> • Describes the time of day using vocabulary such as early, late morning, afternoon and night 	<ul style="list-style-type: none"> • Names in order the days of the week and the months of the year 	
	<ul style="list-style-type: none"> • Orders recurring events in their daily life 	<ul style="list-style-type: none"> • Compares events in terms of the length of time they take (longer, shorter, faster, slower) 	<ul style="list-style-type: none"> • Calculates elapsed time in: <ul style="list-style-type: none"> ▶ Hours and minutes using clocks ▶ Days, weeks and months using calendars 	<ul style="list-style-type: none"> • Solves problems involving calculations with and conversions between: <ul style="list-style-type: none"> ▶ Min → hours ▶ Hours → days ▶ Days → months
	<ul style="list-style-type: none"> • Sequences events within one day 	<ul style="list-style-type: none"> • Sequences events using language such as yesterday, today and tomorrow 	<ul style="list-style-type: none"> • Sequences events according to days, weeks, months and years 	

The learner is able to use appropriate measuring units, instruments and formulae in a variety of contexts				
	Grade R	Grade 1	Grade 2	Grade 3
	We know this when the learner:	We know this when the learner:	We know this when the learner:	We know this when the learner:
Time		<ul style="list-style-type: none"> Places birthdays on a calendar 	<ul style="list-style-type: none"> Identifies important dates on calendars including dates of: <ul style="list-style-type: none"> Religious festivals Historical events 	<ul style="list-style-type: none"> Identifies important dates on calendars including dates of: <ul style="list-style-type: none"> Religious festivals Historical events
Measuring	<ul style="list-style-type: none"> Works concretely comparing and ordering objects using appropriate vocabulary to describe: <ul style="list-style-type: none"> Mass (e.g. light, heavier, heavy) Capacity (e.g. empty or full, less than or more than) Length (e.g. longer, shorter, wider, tall or short) 	<ul style="list-style-type: none"> Estimates, measures, compares and orders 3-D objects using non-standard measures: <ul style="list-style-type: none"> Mass (e.g. bricks, sand-bags) Capacity (e.g. spoons, cups) Length (e.g. hand spans, footsteps) 	<ul style="list-style-type: none"> Estimates, measures, compares and orders 3-D objects using non-standard measures: <ul style="list-style-type: none"> Mass (e.g. bricks, sand-bags) Capacity (e.g. spoons, cups) Length (e.g. hand spans, footsteps) 	<ul style="list-style-type: none"> Estimates, measures, compares and orders 3-D objects using non-standard and standard measures: <ul style="list-style-type: none"> Mass (e.g. packets, kilograms) Capacity (e.g. bottles, litres) Length (e.g. desk lengths, metres)
				<ul style="list-style-type: none"> Investigates (alone and/or as a member of a group or team) and approximates: <ul style="list-style-type: none"> Distance around 2-D shapes using string Area of 2-D shapes using tiling

Time: It is important that Foundation Phase teachers recognise that time is a complex idea and it takes children a very long time to evolve/develop an understanding of time.

There are several reasons why time is a complex idea:

- Watches and clocks mix scales on the same measuring instrument – the 5 on the clock face represents both

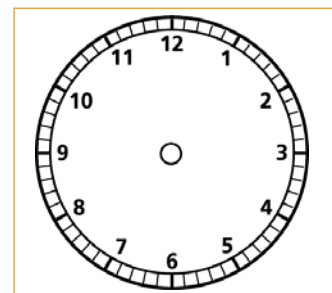

twenty-five minutes and five hours or, for that matter, thirteen hours as well; and the 6 represents thirty minutes, and six or eighteen hours. There is nowhere else that children come across a single scale that describes a range of meanings.

- Time is represented in a range of different ways and using different notations:
 - ▶ Analogue and digital displays, and
 - ▶ 12-hour and 24-hour time
- Time involves not only a mixed notation: years; months, weeks, days, hours, minutes and seconds; but furthermore, there is no discernable pattern: 60 seconds in a minute; 60 minutes in an hour; 24 hours in a day, 7 days in a week and 28,29, 30 or 31 days in a month!
- Working with time involves working with mixed units – hours and minutes – and this in turn introduces the need to make conversions and, as already suggested, there is no obvious pattern to the conversion rates between units at each level. The only other context in which children come across mixed units is money (Rands and cents)

Measuring: The focus in the Foundation Phase is entirely on informal measuring.

In **Grade R** children are *comparing* and *ordering* one or more objects according to one or more properties/attributes in a pair-wise (one on one) manner. They literally take two (or more) objects and ask questions such:

- Which is more and which is less?
- Which is longer and which is shorter?
- Which is lighter and which is heavier? etc.

In **Grade R** measuring involves direct comparison of the properties of physical objects.

In **Grades 1 and 2** more standardised (though still informal) units are introduced:

- Bricks and sandbags for mass;
- Spoons and cups for capacity/volume; and
- Hand spans, arm lengths and footsteps for length etc.

and measurements are determined in terms of multiples of these units.

What Grade 1 and 2 children need to realise is that although the measuring that they are doing is in terms of some “standardised unit(s)”, the choice of the standardised unit is completely arbitrary – that is; almost anything could have been used.

Furthermore, Grade 1 and 2 children also need to realise that the “standardised” unit used by one person could be different to “standardised” unit used by another person. For example: one person’s hand span will be different to the next person’s hand span.

The important lesson is that measuring is not about a number – but also about the units associated with that number.

By **Grade 3** children are introduced to the value of still further standardised units – units such as kilograms, litres and milliliters; and metres and centimeters etc.

Through measuring activities children will come to the realisation that very few objects can be measured in whole numbers of the unit of measurement:

- There are more than 3 spoons but less than 4 of water;
- The table is more than 2 hand spans but less than 3 long; and
- The bag is heavier than 6 bricks but lighter than 7.

Measurement provides an invaluable and natural context for the introduction of fractions. That is, the need for fractions (as parts of a whole) arises quite naturally in the context of measuring.

One last observation to be made about measuring is that it is in the context of measuring that children meet situations where:

- One object can be heavier than another and yet the heavier object is shorter and the lighter object taller, and
- One object can have a smaller perimeter and a larger area than another object with a larger perimeter but smaller area, etc.

Guidelines for practice

Measurement in the Foundation Phase is practical. Measurement is not addressed through worksheets and/or other written activities, it is practical.

Measurement, especially time, in the Foundation Phase is integrated into each and every school day.

Although both time and measuring are in the broadest sense concerned with measurement, these two clusters of Assessment Standards can be dealt with quite independently of each other.

Time: Time in particular should not be taught as an isolated topic to which a number of periods are allocated each quarter. It should rather be dealt with on an ongoing day-to-day basis. Each classroom should have one or more clocks and frequent references should be made to these:

- What is the time?
- How many minutes till break?
- How long is break?
- What will the time be when we come back from break?
- What will the clock look like when we return from break?
- What will the clock look like when we go home?
- What will the clock look like when we watch television tonight? Etc.



Each classroom should have a large calendar with important dates marked on it and frequent references made to it:

- How many more days till the end of the month?
- How many more days till Ashwin's birthday?
- How many more days till the weekend?
- How many days are there in the holiday? etc.

In CAPS, the time cluster shows a slow and deliberate progression from Grade R to Grade 3 – this is expressly because time is such a complex concept and we need to be patient with its introduction and support.

In addition to all the explanations already given about time and why it is such a complex concept, it should be realised that time is largely **social knowledge**: it consists of arbitrary conventions: 60 minutes in an hour and 24 hours in a day. There is no natural way in which a Foundation Phase child can be expected to see why these units and/or values have been chosen. Even the clock – which we as adults take for granted – is a rather unusual device.

Measuring: Measuring should, quite clearly, be experienced by children as a physical activity. They should have frequent opportunities to compare and order a range of objects according to one or more of their properties/attributes: mass; capacity/volume and length(s) to mention but a few.

Estimation plays an important role in measuring – children should develop the habit of first estimating before measuring so that they have some intuitive feeling for the properties and also a way of evaluating the validity of their measurement.

Throughout the Phase the shift is from:

- Direct comparison to comparison of one object with another to
- The use of more formal units of measurement.

The focus throughout the Phase should be on developing the realisation that we can use any units to compare and that all units have their limitations:

- In comparing from one set of measures to the next (i.e. where the same units of measurement have not been used); and
- The properties/attributes we are measuring can seldom be measured in whole numbers of the unit only – introducing the need for either smaller units or parts of a unit (fractions).

An important idea as we develop measuring skills is for children to learn to make a plan: that is, to decide on how to answer a question or solve a problem. The question: *Which is bigger?* can have many different answers depending on which attribute we decide to focus on. If it is weight we can use a simple balance to decide, if it is volume we might place the object in a measuring cylinder with water and see how much water is displaced, if it is area we can place the object on a square grid and count how many squares are covered, if it is height we can simply place the two objects next to each other. The answer to the question: *Which is bigger?* depends on what is being compared

We should avoid the temptation to shift too quickly to the use of standard units – leaving these for Grade 3 as the curriculum suggests and certainly leaving conversions between units to the Intermediate Phase. It is much more important that children struggle with the limitations of their own informal units and solve the problems – by for example choosing to change the units that they use so that they can determine measurements more precisely.

A very important idea related to all of measuring is the notion that answers are seldom an exact value but rather a value within some range. Children often get the impression that mathematics is very precise, that there is only one answer and the answer is exact. Measuring introduces the notion that a value can only be as precise as the measuring device will allow and even then different people will read slightly different values using the same device. By dealing with these issues we are sensitizing children to the important ideas of variation, precision and accuracy.

Activities related to time

Grades R and 1

- **Elapsed time:** Determine how long it takes to complete simple classroom tasks by counting 1, 2, 3 etc until the task is completed. Compare: which tasks take longer?

Use an hour glass and determine how many words you can read; how many breaths you take etc. before the sand has passed through.

Provide children with cards with pictures of different activities on them and have them sequence the cards from activities that take a short time (brushing teeth) to activities that take a longer time (eating a meal) to activities that take an even longer time (playing a soccer match/watching television)

- **Sequencing of events:** Provide children with a story presented through pictures on different cards and have them sequence the cards with justification.

Activities related to time

Grades 2 and 3

- **Elapsed time:** Let children create their own time measuring devices – a cold drink bottle with sand (time being measure by the sand running out) and time how many of a certain task can be completed before the sand runs out.

Work with time tables (buses, television etc) and work out how long different events: journeys programmes etc take.

- **Telling time:** children should by the end of the Foundation Phase, be able to tell the time – let them work in pairs using clocks, taking turns to “make” a time and having their partner tell it.
- **Calculations involving time:** solve problem such as: “It is now half past four, if you must be home by a quarter past five, how long do you have to get home?”
- **Sequencing of events:** Create time lines for each child’s life filling in significant events onto the line.

Create a time-line for the school year filling in significant events – relate this to the calendar.

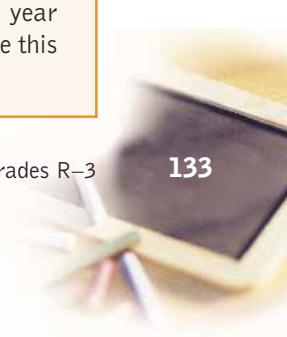

Activities related to measuring

Grades R and 1

- **Length:** Mark each child's height on a chart on the wall every few months and discuss variation/change from one measuring event to the next.

Comparing and ordering objects (sorting according to length) – given a number of objects arrange them from shortest to longest.

- **Capacity:** Use vocabulary such as full, empty, nearly full and nearly empty to describe containers with contents.

Give groups of learners a collection of different sized containers. Let one learner select one of the containers and fill it with sand. Ask the other learners to find containers in the collection that hold more or less than the chosen container. Learners check their predictions by pouring the sand from the first container into the selected container.

Given a bottle fill it with sand/water and determine how many cups can be filled with the sand/water – repeat for different containers and cups.

Activities related to measuring

Grades 2 and 3

- **Length:** Make an informal measuring tape using a given unit of length and use the tape to measure lengths of different objects.

Measure the length of a shadow at intervals during the day and develop an awareness of variation within one day and trends from one day to the next.

Calibrate the classroom (length, breadth and height) – using an appropriate measure.

- **Capacity:** Determine the capacity of different objects either through filling or displacement (placing into a measuring cylinder with water).
- **Mass:** Compare the mass of objects using a balance.
- **Area:** Determine the areas of different objects by counting the squares that the object covers on a square grid – using different grids.





Introduction

Data Handling (more formally Statistics) is a branch of mathematics in which we use mathematical tools to collect, organise, represent and interpret numerical information (data) in order to:

- Answer questions;
- Make sense of situations; and/or
- Make predictions about the future.

In arithmetic we are generally concerned with performing mathematical operations on a few numbers in order to solve a given problem and the solution is typically well-defined by the constraints of the problem/situation. In statistics/data handling, by contrast, we are typically working with a large amount of data (many different numbers), and because it is impossible to work with all of the data at once we try, instead, to describe it.

We live in a world where we are confronted by huge amounts of information on a daily basis. From the results of market research to surveys and opinion polls, we need to be able to make sense of information presented through statistics and graphs.

As critical, involved and contributing citizens we need to be able to:

- Ask questions;
- Evaluate claims based on data;
- Create arguments that we can defend; and
- Use data meaningfully.

In order to develop these skills we should have a sense of how the Data Handling Cycle works. The role of Data Handling in the school curriculum is not so much to create market researchers but rather to develop in individuals a sensitivity to the variables that impact on the Data Handling process.

There are typically two ways in which we describe data:

- Statistics – numerical values, for example:
 - ▶ Measures of central tendency (mean, median and mode) – studied in the Intermediate and Senior Phases; and
 - ▶ Measures of distribution (quartiles, quintiles and percentiles; and standard deviation) – studies in the FET band.
- Pictures – graphs, for example:
 - ▶ Pictograms and bar graphs – studied in the Foundation Phase
 - ▶ Pie charts and histograms – studied in the Intermediate and Senior Phases; and
 - ▶ Cumulative frequency plots – studies in the FET band.



Data handling (statistics) is a process – a well-defined sequence of activities completed in solving a problem. The diagram alongside summarises the process:

- The data handling cycle begins with a **problem** – the reason for engaging in the process at all.
- The next stage of the cycle involves **posing the question**: translating the problem into a question that the data handling process/cycle must answer as well as identifying the source(s) of the data.
 - ▶ The way in which we ask a question impacts on the answer we receive. The questions: “Which television show do you watch most often?” and “Which television show do you like most?” could quite easily elicit different answers.
- Once we have a question and have identified the source of the data, the next thing that we do is **collect the data**.

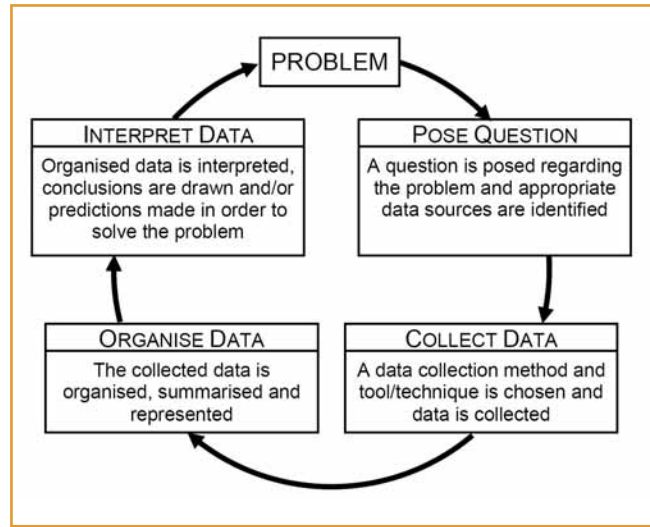

There are different ways in which we can do this and the method we chose will impact on the nature and quality of the data collected. Data collection methods, which may or may not involve **sampling**, include:

- ▶ Observation
- ▶ Interviews
- ▶ Surveys/Questionnaires
- After collecting the data the next challenge is to **organise** it. This can involve:
 - ▶ **Organising** the data using:
 - Tally tables; and/or
 - Two way tables
 - ▶ **Summarising** the data by means of different statistics:
 - Measures of central tendency; and/or
 - Measures of spread
 - ▶ **Representing** the data by means of different graphical representations. Different kinds of graphs commonly used include:
 - Pictographs
 - Bar graphs and histograms
 - Pie charts
 - Cumulative frequency graphs
- Finally, the data needs to be **interpreted** – that is, the results of the data handling cycle need to be analysed in terms of the problem/question that prompted the data handling cycle in the first place.

The key lesson to be learnt from studying the Data Handling cycle (from Grade R through to Grade 12) is that there are choices made (in terms of methods, tools and techniques) at each stage of the cycle/process and that these choices all impact on the conclusions that can be drawn from the cycle/process.

In the Foundation Phase, we begin the journey into Data Handling. The key messages to be conveyed at this stage of the child's development are that:

- The choices we make in working with the data impact on the impression we get – they impact on our description of the data. Typical choices include the different ways in which the same objects (information/data) can be:
 - ▶ Sorted; and
 - ▶ Represented.
- At the heart of Data Handling is the notion of **variation/variability**. This concept is important in two key ways:
 - ▶ The first is that it is reasonable to expect that values/measures will vary.
 - Different people measuring the same object are likely to get answers that vary from one another – variation in measurement has played an important role in the development of the field of statistics.
 - ▶ The second is that the data collected on one day in one context is likely to vary from the data collected on the same day in another context and/or the data collected on one day in one context is likely to vary from the data collected in the same context on another day.

Should we ask Mrs Tobias' Grade 1 class how many children walked to school, how many came by bus and how many came by car then it is reasonable to expect that we will get a different set of answers on each day of the week. It is also reasonable to expect that the answers we collect in Mrs October's class will be different to those we collect in Mrs Tobias' class.

What we know

The challenge in teaching is to create an environment in which children:

- Experience data handling as a purposeful activity;
- Learn that data handling is a cycle with choices made along the way – choices that impact on the process and its outcomes; and
- Develop a sense of and comfort with variation and variability.

Data Handling in the Foundation Phase can be clustered into four clusters which reflect the stages of the Data Handling cycle: **posing questions**; **collecting data**; **organising** and **representing** data; and interpreting data.



The learner is able to collect, summarise, display and critically analyse data in order to draw conclusions and make predictions, and to interpret and determine chance variation.					
Grade R					
Grade 1					
Grade 2					
Grade 3					
We know this when the learner:					
Poses questions					
	Collects data	<ul style="list-style-type: none"> Collects physical objects (alone and/or as a member of a group or team) in the environment according to stated features (e.g. collects 10 dead flowers) 	<ul style="list-style-type: none"> Collects everyday objects (alone and/or as a member of a group or team) in the classroom and school environment according to given criteria/categories 	<ul style="list-style-type: none"> Collects data (alone and/or as a member of a group or team) in the classroom and school environment to answer questions posed by the teacher (e.g. How many learners are there in each classroom?) 	<ul style="list-style-type: none"> Collects data (alone and/or as a member of a group or team) in the classroom and school environment to answer questions posed by the teacher and class (e.g. How many learners walk to school?)
	Organises and represents data	<ul style="list-style-type: none"> Sorts physical objects according to one attribute (property) (e.g. red shapes) 	<ul style="list-style-type: none"> Sorts physical objects according to one attribute chosen for a reason (e.g. sort crayons into colours) 	<ul style="list-style-type: none"> Sorts physical objects according to one attribute chosen by the teacher 	<ul style="list-style-type: none"> Sorts, orders and organises own and supplied data by one or more attribute for a particular reason
			<ul style="list-style-type: none"> Gives reasons for collections being grouped in particular ways 	<ul style="list-style-type: none"> Gives reasons for collections being grouped in particular ways 	
<ul style="list-style-type: none"> Draws a picture as a record of collected objects 		<ul style="list-style-type: none"> Draws a picture as a record of collected objects Constructs pictograms where stickers or stamps represent individual elements in a collection of objects 	<ul style="list-style-type: none"> Draws pictures and constructs pictograms that have a 1-1 correspondence between own data and representations 	<ul style="list-style-type: none"> Draws pictures and constructs pictograms and bar graphs that have a 1-1 correspondence between own data and representation 	
Interprets data	<ul style="list-style-type: none"> Answers questions (e.g. Which has the most?) based on their picture or their sorted objects 	<ul style="list-style-type: none"> Describes his/her collection of objects, explains how it was sorted and answers questions about it 	<ul style="list-style-type: none"> Describes his/her own or a peer's collection of objects, explains how it was sorted and answers questions about it 	<ul style="list-style-type: none"> Reads, interprets and reports on information in own and peer's representations of data Reads and interprets data presented in simple tables and lists 	

The diagram below shows how the Grade 2 content for Data Handling given in the Table on page 138 links directly to the Data Handling cycle described earlier on page 136.

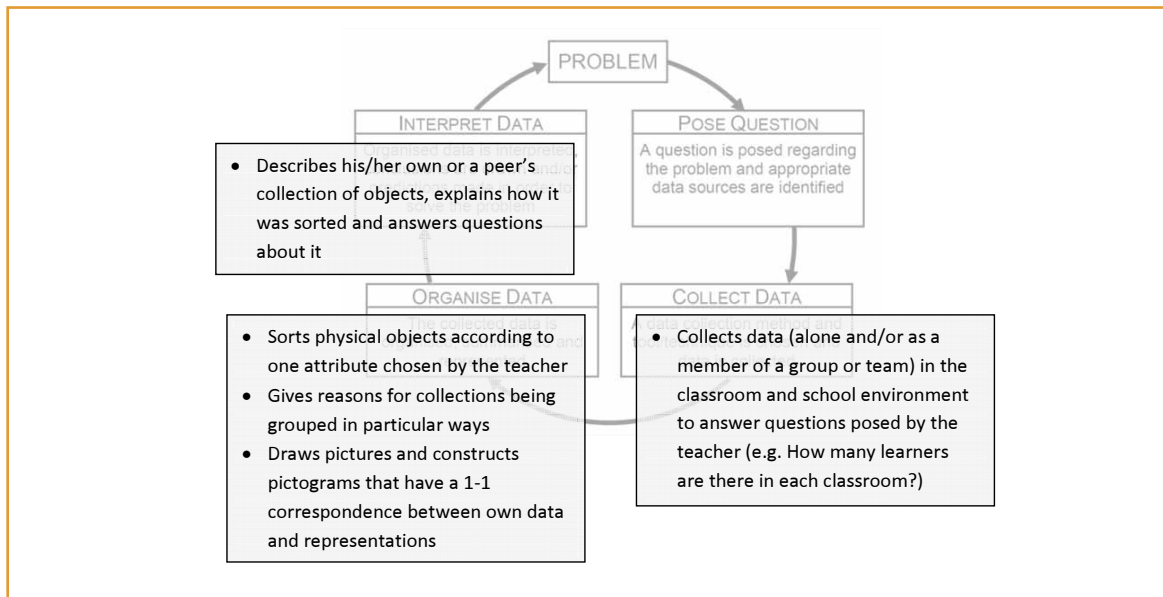

The skills described in the table must be taught systematically and in an integrated way. Collecting data does not happen on one day and/or at some point in the year while sorting happens on another and drawing pictograms on yet another. The three are done in relation to one another using the same data.

Posing questions: It is the role of the Foundation Phase teacher to ask the questions that will lead to the collection and organisation of data.

Based in contexts that are part of the children's world the teacher should ask questions and make assertions:

- Examples of questions:
 - ▶ What is your favourite:
 - Colour, animal, cold drink, cereal?
 - ▶ How did you come to school?
 - ▶ How far do we live from school?
 - ▶ What kinds of shoes do the children in this class wear?
 - ▶ In which months are our birthdays?
- Examples of assertions:
 - ▶ Boys eat more than girls.
 - ▶ Our class creates more rubbish than the other class.
 - ▶ Bananas are the favourite fruit of the children in our class.
 - ▶ More people are absent on Monday than on any other day of the week.

Having posed a question/made an assertion the teacher needs to lead a class discussion about what must be collected and the most efficient way of collecting the materials.

Collecting data: The skills that deal with the collection of data show an interesting progression from Grade R to Grade 3:

- In Grades R and 1 collecting data involves the collection of physical objects. In Grade R children collect objects of a similar kind (10 triangles; 10 flowers; or 10 pieces of fruit). In Grade 1 children collect objects according to criteria or categories (heavy objects, light objects, objects made from paper etc.)
- In Grades 2 and 3 children collect data that is not necessarily physical in nature, instead they ask questions and record the answers of their class mates to these questions. Questions such as:
 - ▶ Which of these is your favourite fruit? (apple, banana, orange, grape)
 - ▶ How do you travel to school? (walk, bus, car, bicycle)
 - ▶ How many brothers and sisters do you have?

The collection of data in Grades 2 and 3 may involve collection sheets and tally marks – by implication teachers need to teach the children in their class how to use tallies.

Boys	#
Girls	#

Organising data – sorting data: In order to be able to organise data, children first need to be able to sort it – that is they need to decide whether or not the things being sorted have the same attribute or different attributes: whether or not they belong to one group or to another.

Children need experience both with sorting items according to criteria provided by the teacher and according to their own criteria.

- When children start sorting according to their own criteria they might sort objects:
 - ▶ According to their attributes (all round objects or green object or plastic objects)
 - ▶ According to their function (objects used to cut paper or objects used to transport people)
 - ▶ Simply because they belong together (mothers and fathers, children, etc)

It is very important that teachers support children in explaining the reasons for sorting the objects in the way that they did. The explanation forces children to reflect and it is through **reflection** that they develop their **conceptual knowledge**.

- When teachers provide the criteria for sorting objects they should:
 - ▶ Start out with situations in which there is a single criterion – objects that meet the criterion and objects that don't (i.e. the sorting process will result in only two piles);
 - ▶ Progress to situations in which objects are sorted according to one criteria and the sorting will result in more than one group (e.g. by sorting according to colours; sorting according to size, sorting according to shape, etc.)

- ▶ Be aware that it will take some time before children can sort objects according to more than one criteria (e.g. size and colour; shape and colour; shape and size etc.) – children should not be expected to be able to do so before they are in Grade 3.

Organising data – representing data: There is a very natural progression in terms of the representation of data.

- Initially the actual collection of sorted objects (sorted according to one or more criteria) represents the data. What should be clear is that with objects simply lying in piles, it is very hard to talk about the collection(s) and more sophisticated representations are needed.
- From simple piles of objects, the representation of data progresses to these same objects arranged in rows to make comparisons easier. Care needs to be taken to ensure that the objects are arranged so that they line up next to each other ensuring that the longer row corresponds to the group containing more objects.
- From representations made using the actual objects we progress to representations made from pictures of the objects – again arranged in rows – to create what are known as pictograms. Care again needs to be taken to ensure that the pictures in the pictogram line up.
- The next developmental stage in representation is to create bar graphs in which we colour blocks rather than using pictures or stickers.

Guess my rule

Guess my rule is a fun activity that can be used to help children develop their ability to describe reasons for objects being sorted in a particular way.

Collect an assortment of classroom objects (pens, pencils, crayons, building blocks, toys, clothing etc.) and place them in a box. The teacher starts out by thinking of a rule. For example “objects that are red” and without telling the group her rule has the children take turns removing objects from the box. The children ask the teacher if the object fits her rule: yes or no and place the objects into two piles – objects that satisfy the rule and objects that don’t. When there are a number of objects in each pile the children get a chance to guess the rule. The first child to guess the rule becomes the new “rule maker” and the game starts again.

Face cards

One way to assist children in relating to the representations of data – especially data involving themselves (e.g. How do you travel to school?) and their opinions (e.g. What is your favourite fruit?) – is to take a photograph of each child and to print it onto a piece of cardboard. This will enable them to place their own card in the appropriate column/row of the representation and so “see themselves” in the representation.

If taking and printing photos is difficult, children can make their own cards by drawing a picture of themselves.



1

2

Bus						
Car						
Walk						

3

Bus						
Car						
Walk						

4

Bus					
Car					
Walk					

Different representations of the same information collected in response to the question: "How do you travel to school?"

1. To develop this representation the children have simply placed their face cards in groups together.
2. A pictogram created using the children's face cards. Each child is still able to see where they fit into the data.
3. A pictogram created using pictures of the modes of transport – one picture corresponds to one child.
4. An early bar graph with one sticker/block per child – the children could also write their names on the stickers.

NOTE: in the same way that it can help to let each child in the class have their own face card which can be used to indicate different groups that children belong to, it also helps to have classroom sets of the pictures used in making pictographs so that each child can take a card corresponding to their preference and place it on the graph.

Interpreting data: There are two key skills to be developed as children learn to interpret data:

- Children need to be able to read information directly from representations. They need to be able to answer questions like:
 - ▶ How many children came to school by bus?
 - ▶ How many children liked apples?
 - ▶ How many children live more than 10km from school?
- Children need to be able to compare information in representations. They need to be able to answer questions like:
 - ▶ Are there more children who come to school by bus or more children who come to school by car?
 - ▶ Are there more children who like apples or more children who like bananas?
 - ▶ How many more children like red compared with yellow?
 - ▶ Which is the most popular TV programme among the children?
 - ▶ Which is the least favourite kind of fruit among the children?
 - ▶ How many groups completed more than 10 sums in the time allowed?

In order to develop the skill of interpreting data teachers need to continuously ask children questions both about their sorted data (Grades R and 1) and their representations of the data (Grades 1, 2 and 3).

As a result of answering questions about data, children develop the skill of making statements about data – statements that they need to be able to justify with reference to the data. Statements such as:

- ▶ Bananas are the favourite fruit among the children in our class.
- ▶ On Tuesday there were more boys than girls at school.
- ▶ Boys eat more sandwiches than girls.

By the time children reach Grade 3 they should also be able to engage in discussions that reflect their understanding of variability and change with respect to data. The required skills are developed by having children answer questions such as:

- ▶ What would happen to the results if we did the same activity again? Why?
- ▶ Do you expect the results of the survey to be the same or different tomorrow? And next week? Why?
- ▶ How would the results be different if we asked older/younger children (or adults)? Why?
- ▶ Would the results be the same in winter and in summer? Why?

Guidelines for practice

Children in the Foundation Phase need to experience Data Handling through practical (hands on) activities in which they:

- Collect data;



- Organise the data by:
 - ▶ Sorting, and
 - ▶ Representing
 it in a variety of different ways: and
- Interpret their data

In order to:

- Answer questions;
- Make sense of situations; and/or
- Make predictions about the future.

Children in the Foundation Phase need to:

- Experience Data Handling as a purposeful/meaningful activity that makes sense.
- Recognise that questions that require Data Handling are different from those that require calculations only. In particular these questions are different in that they involve a large amount of information that needs to be described in order to answer the question.
- Appreciate that the answers developed in Data Handling situations will vary. They will vary as a result of:
 - ▶ Different sources for the data;
 - ▶ The size of the sample/population;
 - ▶ The times of the day; the days of the week; and the months of the year;
 - ▶ The way in which the data was collected; and
 - ▶ The way in which measurements were taken etc

When identifying question for investigation teachers should ask themselves:

- Is the answer to the question important or worth knowing?
- Is the question interesting for the learners?

NOTE: Data Handling provides an excellent opportunity for integration with other subjects and for the development of the Critical Outcomes.

Success in teaching Data Handling relies on well chosen and purposefully developed investigations. Investigations that are appropriate to each Grade include the following.

Making block towers (Grade R)

This activity that also supports the development of counting and can be completed as part of seat work.

- Select 40 stacking cubes (10 each: red, blue, green and yellow).
- Mix the cubes together and as a first task have the children on the mat sort the cubes according to their colour.
- Let each of four children take a handful of cubes from one of the colours and have them make a vertical stack of the cubes – this is a virtual bar graph
 - ▶ How many cubes are there in each child's stack? (children must count)
 - ▶ Who has the most cubes?
 - ▶ Who has the least cubes?
 - ▶ Will each child get the same number of cubes each time? Let us try again...
- Let the children draw a record of the activity using coloured crayons.

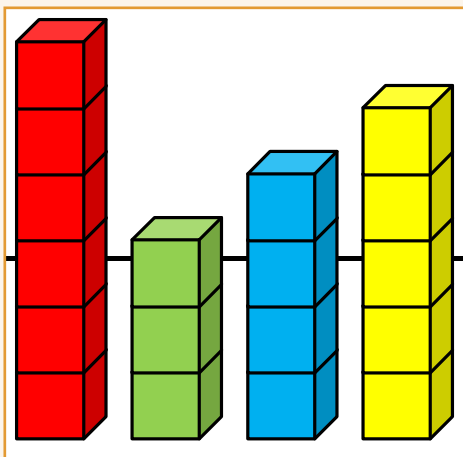

Which is your favourite character (Grade R)

This activity can be linked to a literacy activity.

- The teacher reads the children a story involving a number of characters.
- The teacher asks a few of the children which is their favourite character and allows each child to explain their choice.
- The teacher wonders: "Which is the most popular character in the story?". The children work together to draw one of each of the characters.
- The characters are each stuck to a container.
- Each child in the class is given a chance to place their face card in the container with their favourite character on it.
- The class places the face cards in columns to create a pictograph and to answer the questions posed by the teacher:
 - ▶ How many people believe that ___ is their favourite character?
 - ▶ Which is the favourite character?
 - ▶ Which is the least favourite character?
 - ▶ Would the results be the same if we asked another class? Why?

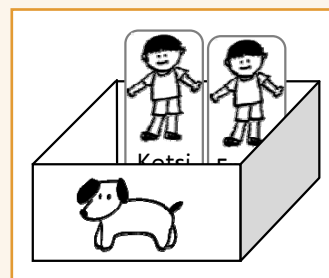

Recording the weather (Grade 1 & 2)

This activity is linked to the development of time and the calendar.



- Every month place a blank calendar on the wall of the classroom and on each day of the month place the weather symbol (above) that best describes the school day.
- At the end of the month develop a pictograph summary for the month using the symbols from the calendar
- Repeat over time and for a number of months (this is to highlight the notion of variability)
- Compare the pictographs asking questions such as:
 - ▶ How many days were sunny in January?
 - ▶ Which month had the most/least rainy days?
 - ▶ Which month had the most least sunny days?
 - ▶ Will next January's pattern be the same as this January's? Why?

Which caps/hats are most popular? (Grade 1 & 2)

This focus on this activity is on the fact that the same data can be sorted in different ways.



- Collect some magazines to be used for this activity.
- Children work through the magazines cutting out any examples of caps/hats that they see in the magazine.
- Ask the question: "How would you describe the hats that you cut out of the magazine?"
- To answer the question children must first sort the caps/hats – high-light how this can be done in different ways:
 - ▶ Purpose/function
 - ▶ Colour
 - ▶ Material
 - ▶ Mens/womens/either
- Make pictographs for each method of sorting and have children take turns answering the question – using their graph to support their argument.

Measuring distances using informal and formal units? (Grade 3)

This activity integrates well with Measurement and highlights the fact that measuring involves variation.

- Each child measures the width and length of the classroom first in terms of foot-lengths and in terms of paces. Each child writes their name and measurement on a square piece of paper supplied by the teacher – do not let children compare their answers until they have written them down.
- Using the measurements made with the informal units develop a bar graph (using the squares of paper) and discuss the trend: while more children will have value nearer “the middle” of the “range” there will be other measures that are further dispersed from the “centre”.
- Repeat the activity above using a standardised ruler or measuring tape and reflect how the range of values may be decreased as a result of the more “standardised” unit, there is still a range of values for the same distance: the width/length of the class.



Are girls taller than boys? (Grade 3)

This activity forces children to make a plan in order to answer a question and also to work through each of the stages of the Data Handling cycle.

- The teacher asks the question: “Are girls taller than boys?”
- Allow for some class discussion focused on: “How can we answer the question?”
- Let the children measure each other recording both height and boy/girl for each measurement.
- Having determined the measurements raise the question – How can we use this information to answer the question? Children may suggest:
 - ▶ Adding the boys’ measures together and the girls’ measures together (this raises problems if there are not the same number of boys and girls).
 - ▶ Comparing the tallest boy with the tallest girl.
 - ▶ Drawing a bar graph for the boys and one for the girls and looking for the most common height in each group and then comparing.
- The focus in this activity is on helping children to realise that there are different ways of comparing the data and that these different ways may well give different answers.

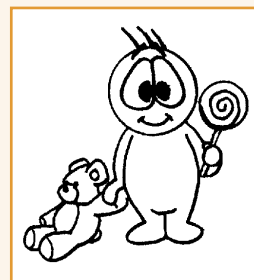

Introduction

This unit takes the form of answers to frequently asked questions that arise as readers reflect on the content of this handbook. The questions addressed in this unit include:

- How does the classroom atmosphere support the development of Numeracy? (page 149)
- What is the place of group-work in the Foundation Phase Numeracy classroom and how should groups be organised (by ability or not)? (page 150)
- What learning and teaching support materials (LTSM) should there be in every Foundation Phase Numeracy Classroom? (page 153)
- Why is discussion so important in the Foundation Phase Numeracy classroom? (page 157)
- What is the role of writing in the Foundation Phase Numeracy Classroom? (page 158)
- How do we incorporate the ideas raised in this handbook into our planning? (page 160)
- How do we plan for assessment and how do we assess in Foundation Phase Numeracy? (page 165)
- What is the role of Mental Mathematics in Foundation Phase Numeracy? (page 170)

How does the classroom atmosphere support the development of Numeracy?

Classroom based learning is profoundly impacted on by the actions of the teacher.

The way in which a teacher organises and manages events in the classroom determines both:

- The atmosphere in which children must work; and
- An understanding of what mathematics is and how it should be learnt.

For children to experience numeracy/mathematics as meaningful, sensible and interesting, the classroom atmosphere must support this. As discussed in Units 2, 3 and 4 children need to experience numeracy/mathematics through activities that stretch their minds and challenge them to think. They need to experience mathematics as a purposeful problem-solving activity. Children must continuously be challenged:

- To think;
- To reason; and
- To make plans.



If the teacher does not allow them to think, reason and make plans and instead shows them how to solve problems very little, if any, learning will take place.

In order for children to think, reason and make plans, they need a classroom atmosphere in which they:

- Feel both safe and comfortable;
- Know that mistakes are accepted and valued as opportunities for learning and are not punished;
- Don't feel alone and isolated when they are working;
- Are not exposed to other children who may intimidate them by working faster, being bossy, trying to show them what to do or making fun of or showing irritation at their work; and
- Have peace and quiet in which to do their thinking.

If children are stressed, they will not try to think, reason and/or make sense, but will rather try to memorise or copy what the teacher and the other children are doing.

Children need teachers who not only know to select the problems and activities that will support their mathematical development, but who will also create and maintain classrooms where:

- All children and their contributions are respected and valued; and
- All children are given the time and the support to make sense of what they are doing.

What is the place of group-work in the Foundation Phase Numeracy classroom and how should groups be organised (by ability or not)?

There is no single answer to this question – the answer is determined by the activities that are taking place.

Teachers of very large (overcrowded) classes, in particular, often say that there is neither the space nor the time for them to work with small groups of children at a time. Ironically the larger the class the less likely it is that children will benefit from whole class teaching.

If we are sincere about letting children think reason and make plans then we also need to give them time to do so.

In classes where the teacher does not give children time to think; reason and make plans but rather gives the answer herself or asks the first child to solve the problem to explain their method to the class, children learn very quickly that they do not need to think hard, because the answer will be supplied. They therefore do not bother to become involved.

We also need to encourage children that although they may struggle to solve problems, we believe that they are capable of doing so.

Teachers should also avoid praising particular methods or strategies too enthusiastically. This leads to children trying to copy it (frequently without understanding), in an attempt to please the teacher. Although the teacher should recognise and commend good thinking or a clear explanation their praise should remain modest.

It is recommended that whole class teaching be kept to a minimum in the Foundation Phase class. The reason is simple: Much of what is said by the teacher during whole class teaching is not retained by learners. In order for learners to pay attention and to engage with what the teacher is saying, requires direct eye contact between the teacher and the child. This is difficult in the context of whole class teaching, in particular in large classes.

Throughout the Foundation Phase it is envisaged that the teacher will work with small groups on the mat while the rest of the class is productively engaged in seatwork activities that mirror those on the mat.

Groups on the mat: These groups should be determined by the children's stage of development with children who are at a similar stage of development being in the same mat-work group. Each mat-work group should:

- Consist of between 6 and 8 children;
- Meet with the teacher on the mat at least 3 to 4 times per week; and
- Should be involved in learning activities on the mat that are suited to their level of development.

Teachers should expect to change the composition of the mat-work group every three to four weeks.

Children who are busy working on tasks at their seats: While the teacher is busy with the groups on the mat, the remainder of the children are sitting in their chairs at their desks productively engaged in activities that mirror the work that they have been doing with the teacher on the mat (see the discussion of this in Unit 3). In terms of the children sitting at their seats working on tasks set by the teacher:

- It makes good sense for them to be grouped so that they can help each other solve and make sense of the tasks that they have been set.
- The groups should be as small as possible (this may be impacted on by the size of the classroom and the available furniture):
 - ▶ Grouping children in pairs, will help to reduce the noise level and distractions hence making it easier to maintain discipline.
 - ▶ Groups of four children will increase the skills among the children hence providing more support to each of the children in the group.

Although it is common practice to talk about children's "ability", the use of the term "ability" (as in **ability grouping**) can have a very limiting impact on both a teacher's expectations of their learners and on the way in which children experience school.

While it is true that different children in a class will be at different stages of development with respect to different topics at different times of the year, this is not necessarily an indication of their ability. By regarding those children who are more developed than others as having greater ability and those who are less developed as having less ability we limit our expectations of them. These expectations, in turn, become self-fulfilling.

The implication is that teachers need to have a very good sense of where each of the children in her class is at any moment with respect to a



- ▶ Groups of six or more children are too large and should be avoided unless the furniture does not allow otherwise.
- The kind of work with which the children are busy will determine how they are seated/grouped:
 - ▶ If the children are busy with number development and/or problem solving activities (i.e. L01 and L02 activities) then it is better that they are seated together with children who are at a similar stage of development.
 - ▶ If the children are busy with Measuring (L04); Space and Shape (L03); and/or Data handling (L05) activities – i.e. activities that contribute to the development of **physical knowledge**, then there is much to be gained from grouping children at different levels of development together.

developmental path (described by the curriculum) and needs to:

- Provide appropriate, differentiated, activities for the children in her class;
- Have an expectation that all children can achieve the age appropriate expectations of the curriculum; and
- Anticipate changing children from one group to another (throughout the year) as their stage of development changes.

NOTE:

- Do not underestimate those children who are not as developed as the others. They need to be continuously challenged and encouraged to develop better plans etc. Feeling sorry for these children and/or showing them what to do will encourage them to stop trying altogether.
- Do not label children – it impacts on your own expectations of them and it impacts on their self-concept and hence confidence.

The role of discipline: The extent to which teachers can organise their classes as described above is determined in large part by the discipline that they create in the classroom.

It is the role of the teacher to create a classroom environment in which children know:

- That it is unacceptable for them to make a noise and/or behave in a way that disrupts the other children;
- That they are expected to work on the tasks set, taking responsibility

The nature of the tasks set by the teacher for children at their seats can have an enormous impact on their behaviour. Both tasks that are too easy and/or too difficult will lead to restlessness.

Boredom and feelings of helplessness cause unruly behaviour.

for their own learning. While children should be encouraged to discuss their understanding of the work, they should be discouraged from copying directly from each other;

- That they should not wander around the classroom while they have been assigned a task to complete at their seats;
- That they should not interrupt the teacher while she is busy with a group on the mat;
- What to do when they have completed the task that has been set for them: e.g. read a book and/or work on a challenge task etc.
- That there are well-defined boundaries with regard to behaviour and that the teacher will not hesitate to deal with children who do not conform to these.

What learning and teaching support materials (LTSM) should there be in every Foundation Phase Numeracy Classroom?

The Foundation Phase child needs a lot of experiences with physical objects – in part to develop their **physical knowledge** and in part as a tool of sense making. The following list LTSM is no exhaustive but does suggest a minimum list of materials:

Mat-work activities (for L01): The teacher should have access to the following at the mat:

- Counters
 - ▶ Large broad beans, bottle tops and plastic counters are ideal.
- Cards with dots, with numbers and with numbers words (see page 29).
- 100 chart
 - ▶ A 100 chart – preferably one that goes beyond 100 to say 140 or more needs to be available for the development of social knowledge.
- Counting frames.
- Flard cards.
- Number lines
 - ▶ Measuring tapes – a measuring tape can act as an early number line
 - ▶ Examples of a number-line with which to get children started on using numbers lines.
- Money for money problems.
- Mat-work booklets and pencils
 - ▶ Each child should have a mat-work booklet (preferably A5) for use when working with the teacher on the mat.
- Recording booklet
 - ▶ The teacher should have a booklet at the mat in which she makes daily observations with respect to each child. Observations about:
 - The extent to which each child can count;

NOTE: The expectation is NOT that children will work with number lines with each and every number marked on them, but rather that they will develop a “mental number line” and that they will learn to make sketches of this filling in only the numbers needed to solve the problem.



- The number level at which each child is working;
- The range of strategies, tools and techniques used; and
- The ability of each child to explain their thinking.
- Preparation booklet in which the teacher has the list of problems that she has planned to cover during the mat-work sessions.
- A small board (chalk or white board) on which the teacher can write numbers and problems etc while working with the children on the mat.

Seat-work activities: In order for the successful implementation of seat-work, the following are needed:

- Activities for children to complete. The success of seat-work relies on children having materials/activities to work on. The nature of these activities has been described in Units 3, 4 and 5. These can be made available to children in a range of different formats:
 - ▶ Textbooks
 - Textbooks can also be a powerful source of activities for children to work from during seat-work time. There are several advantages that textbooks offer:
 - By working through a (good) textbook systematically through the year we ensure that each child completes the requirements of curriculum at an age appropriate level;
 - The textbook can be re-used from one year to the next;
 - If taken home by the children, a textbook can provide parents with an image of what is being done at school and in so doing allow the parent to support the development of their child.
 - Each class should have at a minimum a classroom set of textbook although it is preferable that each child should have their own textbook for the duration of the year – a book that they can also take home.

There are many reasons given by schools for why they don't have/use textbooks for Numeracy in the Foundation Phase:

- The school does not have the money to buy them. – This is not true. The national Department of Education has provided each school with enough money to buy a textbook for each child in every subject.
- The children do not know how to look after the books. – This is not a good enough reason; children are at school to learn, among other things, how to look after their belongings including books.
- The children cannot read (especially in Grades R and 1). – How will children learn to read if they are not given access to written text?
- The books will get lost. – While it is true to say that if the books are not used they cannot get lost, it is not good enough to deny all children access to a textbook because some of them may lose the book.

To deny a child access to a textbook is to deny them access to learning!

- ▶ Workbooks
 - The Teacher should use the DBE Workbook to reinforce and consolidate skills and concepts that have been taught. The Workbook activities should be mediated in whole class and small group focused sessions.
 - In the case of workbooks each child has their own workbook of activities that they can work through at a pace that matches their level of development. The advantage of a workbook is that each child has their own workbook in which they can write.
- ▶ Activity cards
 - Activity cards – a collection of cards with activities (to be completed by the children) on them. Typically a child will take a card from a box in the corner of the classroom – complete the activity in their class-work book (indicating clearly which card they have been working on) and then take the next card in sequence from the box. The advantage of this approach is that it allows for easier differentiation in terms of matching activities to the extent of each child’s development.
- Counters
 - ▶ Children who are still at Level 1 in terms of their number development should have access to counters to help them make sense of and solve problems.
- Counting frames
- Flard cards
- Number lines
 - ▶ See earlier comment

LTSM for Patterns, Functions and Algebra: In addition to patterning activities there are not a lot of LTSM that are essential for Patterns, Functions and Algebra. That said, it would help if the following materials were available:

- Beads, strings to put the beads on and cards with patterns to be copied and extended;
- Peg boards and cards with patterns/pictures to be copied onto the peg boards; and
- Geometric shapes and objects and cards with patterns to be copied and extended.

LTSM for Space and Shape (Geometry): The Space and Shape cluster make it quite clear that children need to **make** shapes and objects. For this reason it is critical that there are a range of resources available for children to build shapes and objects with. Recall also that children need to use these resources in both periods of **free play** (opportunities to be guided by their imaginations) and periods of **focused play** (activities in which the child is told to make a particular shape or object using the materials provided). For the periods of focused play the teacher also need sets of cards with suggestion of things that can be made using the materials. In summary each classroom should have at least:

- A collection of building blocks of different sizes, shapes and colours;
- Interlocking *unifix* type cubes in a range of colours;



- Sets of geometric shapes (sometimes referred to attribute blocks);
- 2D-shapes that can be joined to make 3D-objects (see the example of shapes that can be joined with elastic bands described in Unit 7);
- Tangrams and similar puzzles;
- Construction kits;
- Maps of the classroom and school for activities related to position; and
- Paper, cardboard, pairs of scissors and glue, etc. with which to make shapes and objects and with which to study symmetry through folding, cutting and unfolding etc.

LTSM for Measurement: Measurement are organised in two clusters: a cluster that deals with time and a cluster that deals with measuring.

For the study of time it is important that each classroom has at least:

- One or two large (working) clocks that show the time and which can continuously be referred to by the teacher throughout the day;
- A number of smaller clocks on which children can change and set the time – although it is tempting to provide children with “mini clocks” whose hands move independently (because these are relatively inexpensive) it is better to have clocks where the two hands are linked;
- Calendars that are used to mark events such as birthdays, holidays and major events; and
- Calendars onto which data is recorded on a daily basis for use in the Data Handling activities – for example: the weather, daily absentees etc.

For the study of measuring it is important that each classroom has a large collection of containers and other materials that can be used to make informal comparisons and measurements related to: capacity (volume), weight and length. Containers and other materials include:

- Sand and blocks/bricks (for capacity);
- Sandbags (for weight);
- Cups and buckets (for capacity);
- A range of household containers such as bottles, boxes, and other regular and irregular containers; and
- Lengths of rope and pieces of stick with which to invent informal measuring instruments (for length).

LTSM for Data Handling: Data Handling is organised into clusters related to the Data Handling cycle: collecting, organising and representing, and interpreting data. In terms of LTSM, the classroom should have:

- Objects to be sorted in a range of different ways (the shapes and objects already mentioned among the LTSM should be sufficient here);

- Pictures and face cards suitable for making the pictographs used in the Foundation Phase to represent data; and
- Graphing grids on which to make the pictographs.

In addition to the LTSM already mentioned, it would also be fantastic if each classroom could have several **games** – games that require logic and which develop mathematical skills. Examples of games include:

- Maths 24;
- Uno;
- Snakes and ladders;
- Dominoes;
- Dice;
- Jigsaw puzzles;
- Dice; and
- Playing cards.

Finally, it is important that teachers also have:

- A range of textbooks that they can refer to as they develop teaching and learning activities;
- Resource packs with activities for the different Learning Outcomes
- Record files of activities used in previous years;
- Record files of assessment tasks used in previous years; and
- Interest books related to mathematics including books with mathematical challenges appropriate to the Foundation Phase.

Why is discussion so important in the Foundation Phase Numeracy classroom?

Discussion is central to learning, discussion leads to reflection and reflection leads to learning.

It is only through discussion that children think about what they have done and try to understand what others have done and in so doing come to see the patterns, properties and relationships that underpin mathematics/numeracy and mathematical thinking.

It is expressly because discussion is so important that the use of whole class teaching in the Foundation Phase Numeracy classroom is discouraged (refer to the earlier discussion in this regard) – not enough children are able to participate in whole class situations.

During **mat-work sessions** when the teacher is working with small groups each child gets a chance to talk and the other children a chance to listen. The teacher encourages



reflective discussion by asking questions such as:

- “Can you explain that? I don’t follow your thinking.”;
- “Do you agree with Peter? Perhaps he should explain it again.”;
- “Do you think that this is the correct way of writing it? How can we write it more clearly?”;
- “Look, Megan did it in a different way. Explain it to us, Megan.”

These questions all help children to focus on the mathematical ideas offered by the problem.

Interaction in the form of discussion and argument which stimulates thinking will occur only if the children have something worthwhile to discuss. They need to be confronted with problems which make sense to them even if they are difficult.

If the problems are too easy, children (quite rightly) prefer to work individually and simply finish their work.

By sitting children in small groups for their **seat-work** activities and encouraging them to work together and help each other, the teacher also encourages discussion between children.

What is the role of writing in the Foundation Phase Numeracy Classroom?

In numeracy/mathematics we use recording for at least two different reasons:

- Recording helps people to organise their ideas and to provide a record of their thought processes. Recording allows a person can to read through their record again, think about what they did finding the cause of their mistake(s) if there were any.
- Recording is provides an opportunity to explain your reasoning/thinking/approach to other people. This enables others to think about the method and either to learn from it or perhaps to improve on it.

In order for a record of work to be used to explain a method or way of thinking to another person:

- The recording should be clear and fairly neat; and
- The mathematical symbols used, should be used correctly (i.e. according to the social norms associated with them – **social knowledge**).

Because we are, in the Foundation Phase, dealing with children who are learning how to record clearly and use symbols in an acceptable way, teachers should ask children to do all their recording, writing and drawings made to solve the problem in such a way that somebody else can easily follow their thinking. Children should be encouraged to rather draw and/or write more rather than less – the focus is on conveying a method of solution as clearly as possible rather than just providing an answer.

Some general remarks about written work:

- The teacher is responsible for teaching acceptable recording practices – **social knowledge**. At first the teacher will have to help children to write down **their** thinking in an acceptable way, using the mathematical symbols correctly. To do this successfully the teacher should **listen very carefully** to the child's explanation to ensure that the record reflects the child's thinking and not what the teacher thinks she heard.

When children start writing down their thinking, they often use the equals sign incorrectly. To avoid this it is recommended that teachers introduce children to arrows which they can use to describe their thinking process.

It is important for their long term mathematical development that that children do not start out using the equals sign badly.

- Do not expect children to write number sentences **before** they start working on a problem. Children will almost certainly be able to solve the problem long before they can write a number sentence. Having solved the problem the teacher can help them to choose or develop a suitable number sentence to describe what they did.
- Encourage children to use the mathematical symbols correctly. Where necessary, it is important that children realise that the teacher is being critical of their recording and not of their thinking.
- Teachers need to ensure that children develop the habit of stating their answers clearly.
- Grade R children should learn the number symbols and how to write them, but they should not be expected to write number sentences (e.g. $2 + 2 = 4$; $3 + 4 = 7$).

When teacher pose word problems for them, the children should solve them in whatever way they find convenient (marks, counters, etc.) and give their answer orally. Once they are able to the children should point to the correct number symbol and, with time be expected to write it.

For example a child might argue that $8 + 9$ is 17 because $8 + 8 = 16$ and $8 + 9$ is one more.

Typically children will write this as $8 + 8 = 16 + 1 = 17$, which is not an acceptable use of the equal sign.

The teacher should rather introduce the alternative notation: $8 + 8 \rightarrow 16 + 1 \rightarrow 17$.

Be sure that the number sentence describes what the child did. For example, a word problem might state: "Ben has R5. He wants to buy a hamburger that costs R12. How much money does he still need?" Although the teacher may think that the number sentence should be $12 - 5 = 7$, the children thinks that it should be $5 + 7 = 12$, because they solved the problem by counting from 5 to 12, and not by subtracting 5 from 12.



How do we incorporate the ideas raised in this Handbook into our planning?

Lesson Planning: In order to ensure that the curriculum is covered (planned, taught and assessed) as set out in CAPS it is important that lesson planning is done systematically ie. the content set out for the term in each grade is covered adequately over the 10 weeks in the term.

The only level of planning that is required in CAPS is lesson planning. The school will decide whether daily or weekly lesson plans are required. The most important aspects of lesson planning is to plan activities for whole class teaching and small group teaching sessions (for at least two groups per day).

Every Mathematics lesson should include Counting Activities, Mental Mathematics, Number sense and Concept development and Problem solving which must be done either in the Whole class lesson or small group focused lesson. It is important that all activities are concretized (done orally and practically first) and that learners are given written recording activities too in every lesson.

It is important when doing lesson planning to take the CAPS Mathematics document and plan activities for the content that is set out for the term in each grade as well as make reference to the Clarification notes (exemplar activities) for all skills and concepts.

The **DBE Workbook** is also an invaluable resource for lesson planning. The Workbook activities are set out per week in every term for each grade. The Workbook activities should be mediated in whole class and small group focused lesson sessions.

The Workbook must be used as a resource to reinforce and consolidate skills and concepts already taught.

The **Learner Book and Teacher Guide** that are recommended for Mathematics in the **National Catalogue for Foundation Phase** must also be used as additional resources.

The **Foundations for Learning** Lesson Plans should also be used as a resource for developing lesson plans too.



How do we plan for assessment and how do we assess?

The purpose of assessment is to find out what each child is able to do so that the teacher is able to plan how best to help the child.

Teaching and learning are related activities.

- the one hand the teacher develops learning opportunities in order for children to achieve the expectations that we have for them and teachers assesses children to see if they achieved what we wanted them to achieve.
- On the other hand, the teacher uses the results of the assessment to reflect on her method of teaching and to think about how she could have taught the material in a more effective way to better help the child develop the skills and/or acquire the knowledge.

The role of assessment is NOT to:

- Complete a portfolio of evidence;
- Decide whether or not a child gets promoted from one year to the next; or
- “Catch the child out”.

The role of assessment is to “catch the child doing something right”.

Assessment should be used to establish what a child knows and can do (doesn’t know and cannot do) so that we can plan our teaching and learning activities to help the child in their development.

Assessment is a process of collecting, synthesising and interpreting information to assist teachers, parents and other stakeholders in making decisions about the progress of learners. Classroom assessment should provide an indication of learner achievement in the most effective and efficient manner by ensuring that adequate evidence is collected using various forms of assessment.

Classroom assessment should be both formal and informal, in both cases feedback should be given to the learner.

(National Policy on Assessment and Qualifications for Schools in the GET Band: DoE, 2007)



Types of assessment

At the start of any year (or at the start of a new topic) we may have children complete some form of **baseline assessment(s)**. The purpose of this is to establish what pre-knowledge and skills the child comes to class with – this information allows the teacher to plan her teaching to match the needs of her class. There is no point starting each year with exactly the same sequence of lessons:

- Some children might not have the pre-requisite knowledge/skills to make sense of the lesson sequence and will be frustrated and confused;
- Other children may already know and be able to do more than the lesson sequence addresses and they will be bored and frustrated.

Throughout the year we **continually** conduct both **informal** and **formal** assessments to monitor the progress of each child. These assessments assist in making day-to-day decisions about the teaching and learning activities. With teachers continually adapting the learning and teaching activities to the needs of the children in the class.

Because this assessment is ongoing, or *continuous*, it is often referred to as **continuous assessment**. Because the purpose of this assessment is to support the development of the child it is also known as **formative assessment** or *assessment for learning*.

An illustration of assessment shaping teaching and learning:

A teacher sets the children in her class a task to complete. As she walks around the class looking at the children working on the task she soon realises that not all of the children are doing what she expected them to be doing. So she stops the class and explains the task again – maybe in a different way to avoid the misunderstanding.

The teacher's observation of the children is an (informal) assessment.

The teacher's decision to re-explain the task is an example of assessment impacting on teaching. She is adjusting her teaching in response to the realisation that the children are not doing what she thought they would.

At the end of a term or year we want to know how the child has developed over the term or year and hence conduct an assessment task or series of assessment tasks to measure this development.

Because the purpose of this assessment is to see how the child has developed over a period of time, it is often referred to as **summative assessment** or *assessment of learning*.

Informal and formal assessment

Informal assessment is ongoing throughout each day. When the teacher:

- Is working with children on the mat (see Units 3 and 5) and a child counts *twenty-seven; twenty-eight; twenty-nine; twenty- ten* ... then the teacher has got feedback (assessment) and knows that this child does not know the sequence of number

names beyond twenty-nine and allows this to determine what to do next. She may decide to:

- ▶ Let the child try again;
 - ▶ Count on the 100 board; or
 - ▶ Let the child listen to somebody else before trying again.
- Sets children a problem and one child solves it by drawing the physical objects and counting and another child solves the problem by means of breaking down the numbers and rebuilding them. Then the teacher knows that the first child is almost certainly at Level 1 in terms of his/her number development while the second child could be at Level 3. With the first child she may decide to do more counting activities – including skip-counting with grouped objects, while with the second child she may try to increase the size of the numbers in the problems.
 - Is playing *up and down the number line* (see Units 3 and 5) with the children on the mat and asks two children to explain how they determined that $17 + 8$ was 25, and the first child says: “*I took the 17 and counted (pointing to her fingers) eighteen; nineteen; ...*” then the teacher has a sense that this child is counting on (i.e. at level 2 in terms of their development) and is either not ready to play *up and down the number line* or needs to do so with smaller numbers. If the second child explains: “*I took three from the eight to make twenty which left me with five, I added this to 20 and I got 25*”, then the teacher knows that this child is using the technique of completing tens in order to bridge tens.
 - Has given a child some items and has asked him/her to sort them according to their colour, and the child’s sorting results in piles with mixed colours then the teacher knows that either the child does not know what is meant by the word colour (i.e. is lacking social knowledge), or did not understand the instruction, or there may be another explanation. Irrespective the teacher needs to reflect on what may be causing the child to do what he/she has done and then to decide on a plan of action to help the child.

Two thoughts:

- Throughout assessment (both formal and informal) it is very important that the teacher asks children questions to confirm whether or not she has interpreted the cause of the child’s error correctly. Without asking and verifying her assumption she may well decide on the wrong course of action. For example the child who drew the physical objects to solve a problem may well be able to do the problem using numbers, but might be drawing the physical objects because he believes that this is what the teacher “wants” him to do. The point is that counting activities may not be what is appropriate for this child at this stage.
- Teachers are often frustrated by children who cannot do today what they could seemingly do with ease only yesterday. They may even call the child lazy or disinterested. This is not the case. We should approach teaching and assessment with the belief that children are doing the very best that they can, they are sincerely doing what they think they should be doing. If what the child does is not what the teacher expected then the teacher needs to reflect on her teaching!



The point made by the examples above is that assessment is ongoing – every interaction between the teacher and the child is an opportunity for assessment. If the teacher does not record (in a record book) what she has observed then the assessment is referred to as **informal assessment**.

The difference between **informal** and **formal** assessment is only in the recording. Informal assessment is not recorded and as such cannot be used as “evidence” when reporting on the child’s progress. By contrast the observations made during formal assessment are recorded in a record book and therefore constitute “evidence” that can be used in meetings about the child and/or in preparing reports on the child.

Forms of Assessment

- **Observation**

Observation involves the teacher watching a child doing something. In the case of Foundation Phase Numeracy, this is an appropriate form of assessment for assessing:

- ▶ Counting physical objects and problem solving
- ▶ Making shapes and objects
- ▶ Measuring
- ▶ The collecting and sorting of data

- **Oral**

Oral involves the child talking to do something and/or to explain something. In the case of Foundation Phase Numeracy, this is an appropriate form of assessment for assessing:

- ▶ Counting (both rote and rational), explaining own solution methods, and critiquing the solution methods of others
- ▶ Describing patterns
- ▶ Describing the criteria used to sort objects and/or the story told by a representation (e.g. pictogram)

- **Practical Demonstrations**

Practical demonstration involves the demonstration of a skill to complete a task. In the case of Foundation Phase Numeracy, this is an appropriate form of assessment for assessing:

- ▶ Rational counting
- ▶ Making shapes and objects
- ▶ Measuring and telling the time
- ▶ Making a pictograph

- **Written Tasks**

Written tasks, as the title suggests involves the child completing a task by writing something down and submitting the written work. In the case of Foundation Phase Numeracy, this is an appropriate form of assessment for assessing:

- ▶ Problem solving
 - ▶ Pattern creation and extension
 - ▶ Making a pictograph
- **Research (Projects, Investigations etc)**
 Research which involves children involved in extended tasks such as projects and investigations over an extended period of time are at best suited to Grade 3 children in Foundation Phase Numeracy. Children in Grades R through 2 should not be expected to conduct independent research tasks. Of course the teacher can manage research tasks done by children at this age, but to expect children to do so independently is unreasonable.

For examples of **observations; orals; practical demonstrations; and written tasks** refer to Appendix B.

What is the role of Mental Mathematics in Foundation Phase Numeracy?

Although mental mathematics is a term that is used quite widely, it means different things to different people.

As discussed in Unit 3, it is important that children develop a strong sense of number. Having a strong sense of number includes among other things (refer back to Unit 3):

- Having a sense of the muchness of numbers – that is having a sense of the relative sizes of numbers: 25 is larger than 5 and 500 is much larger than both;
- Being able to break-down, rearrange and build up numbers in a wide range of different ways. Techniques that contribute to a child’s comfort with breaking down, rearranging and building up numbers include:
 - ▶ Completing tens (and hundreds);
 - ▶ Bridging tens (and hundreds) often by first completing the tens (and hundreds);
 - ▶ Adding and subtracting to multiples of ten;
 - ▶ Adding and subtracting multiples of ten;
 - ▶ Breaking numbers up into their constituent 100s, 10s and 1s e.g. $248 = 200 + 40 + 8$ etc; and
 - ▶ Knowing a range of basic number facts such as:
 - The bonds of numbers up to at least 15.
 - Multiplication facts for product up to 50.
- Having a mental number line – that is having an image of the relative positions of different numbers with respect to each other and being able to move from one number to another either by addition or subtraction; and
- Knowing the properties of the basic operations: e.g. knowing that $5 \times 6 = 6 \times 5$; $3 + 5 = 5 + 3$; and knowing that $4 \div 2 \neq 2 \div 4$ etc.



In this handbook we take mental mathematics to mean – having a strong sense of number. In other words mental mathematics means working with numbers in the way that has been described above without having to resort to paper and pencil to do so.

The key question for the classroom is how to help children develop these skills.

- Is it by drilling them to the point that children can repeat the “number facts” from memory?
- or
- Is it by helping children to develop a deep and rich sense of number through a range of activities and reflection on the patterns that are present in the activities?

Sadly many people’s impression of being able to do mathematics (and of mental mathematics) is of children being able to recall number facts from memory. This impression of mathematics regards all of mathematical knowledge as **social knowledge** – knowledge to be remembered and to be recalled as and when requested. This impression results in teachers expecting children to be able to repeat number facts from memory. The problem with this impression of mathematics is that there are simply too many facts for anybody to remember.

This handbook takes the view that Mathematics is sensible, meaningful and purposeful activity – that we learn mathematics in order to solve problems. This handbook takes the view that mathematics can be **understood, applied** to solve non-routine problems and **explained** (recall the strands of *Mathematical Proficiency* described in Unit 2). And this handbook takes the view that in order for children to experience mathematics in this way they need a strong sense of number. This handbook takes the view that in order to develop a strong sense of number requires that children be exposed to a wide range of activities that will reveal the underlying patterns to children.

The activities referred to are described in great detail Unit 3 and include:

- The use of Flard cards
- Up and down the number line
- Written activities that reveal number patterns such as:
 - ▶ Tables;
 - ▶ Patterns;
 - ▶ Flow diagrams;
 - ▶ Number chains; etc.



Appendix A – Exemplars for planning and assessment

Illustrative Grade 2 Lesson Plan for Term 2

Term 2	
<p>CONTENT AREA Patterns, Functions and Algebra</p> <p>Day 4: Written Recording: Worksheet and Marking Memorandum Day 6: Written Recording: Worksheet and Marking Memorandum</p>	<p>MATHEMATICAL SKILLS</p> <ul style="list-style-type: none"> Copies and extends simple number sequences to at least 20 Creates their own patterns Describes observed patterns <p>RESOURCES</p> <ul style="list-style-type: none"> Problems Counters 100 chart Mat books, teacher's record book Seat work exercises
<p>LOOKING BACKWARDS:</p> <ul style="list-style-type: none"> Strong number concept 	<p>LOOKING FORWARDS:</p> <ul style="list-style-type: none"> Multiplication tables
SEQUENCE OF ACTIVITIES FOR GROUPS ON THE MAT	
<ul style="list-style-type: none"> <u>Daily:</u> <ul style="list-style-type: none"> Rational counting up to Count ears of everyone in group (encourage them to do skip counting) Count fingers of everyone in group (encourage skip counting in 5's or 10's) Skip counting on counting frame in 2's and 4's [...'s] (Learners take turns) [Change the number used for skip counting according to multiple focused on in problems on mat for sessions 2 and 3.] Give everyone in group [20] [30]..... counters and every learner must group the counters in [any way they want]. The counters are then counted in the groups. Learners take turns. Play up and down the number ladder. First session with each group: Pose problems <ol style="list-style-type: none"> There are [28] shoes. How many boys are there? There are [7] tables in a room. Four people sit at a table. How many people are in the room? There are [9] cars in the garage. How many wheels are there? 	<p>4. Mother bakes cookies. She puts the cookies in rows on a baking tray. There are 36 cookies on the baking tray. How many rows are there? Explain the word "multiple" by using multiples of 2 as example. Ask learners to write down multiples of 4.</p> <ul style="list-style-type: none"> Second session with group: Pose similar problems to those in session 1 with multiples of 5 and 10. Third session with group: Pose similar problems to those in session 1 and 2 with multiples of 3 and 6. Day 4 Assessment task whole class: worksheet Day 5 Reflection on worksheet of day 4 Day 6: Assessment Task: Investigation.
SEATWORK ACTIVITIES	
<ul style="list-style-type: none"> Number activities that focus on patterns. Complete number sequences 	<ul style="list-style-type: none"> Complete tables Colour in every $[2^{\text{nd}}/3^{\text{rd}}/4^{\text{th}}]$ number on 100 chart. Ask questions about multiples.

Illustrative Grade 2 Assessment Task for Lesson Plan for Term 2

Worksheet

Name: _____

1. Complete the number patterns:

a. 24; 26; 28; _____; _____; _____; _____; _____; _____

b. 94; 95; 96; _____; _____; _____; _____; _____; _____

c. 30; 40; 50; _____; _____; _____; _____; _____; _____

2. Complete the tables:

a.

Cats	1	2	3	4	5	8
Legs	4	8				

b.

Dogs	1	4	6			10
Legs	4	16		32	36	

c.

Egg boxes	1	2	3	5	6	8
Eggs	6	12				

3. Complete the flow diagrams:

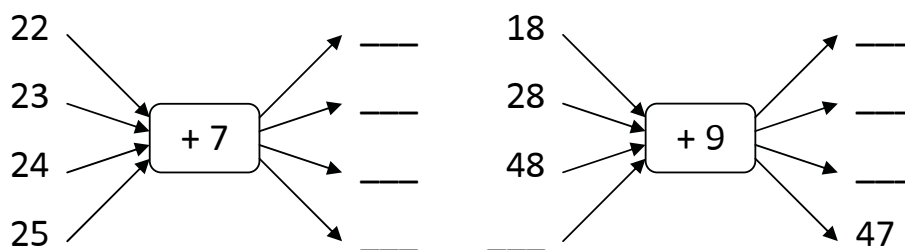

4. Make your own number pattern with 6 numbers.

Memorandum for Illustrative Grade 2 Assessment Task for Lesson Plan for Term 2

Worksheet

Name: _____ Memorandum _____

1. Complete the number patterns:

a. 24; 26; 28; **30; 32; 34; 36; 38; 40**

b. 94; 95; 96; **97; 98; 99; 100; 101; 102**

c. 30; 40; 50; **60; 70; 80; 90; 100; 110**

2. Complete the tables:

a.

Cats	1	2	3	4	5	8
Legs	4	8	12	16	20	32

b.

Dogs	1	4	6	8	9	10
Legs	4	16	24	32	36	40

c.

Egg boxes	1	2	3	5	6	8
Eggs	6	12	18	30	36	48

3. Complete the flow diagrams:

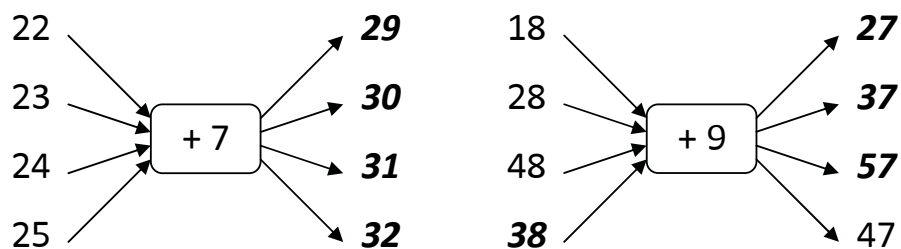

4. Make your own number pattern with 6 numbers.

Any valid number pattern

Illustrative Grade 2 Assessment Task for Lesson Plan for Term 2

WORKSHEET OPTION I

This is a page from a calendar for June 2009:

It shows Ben's birthday on June 10.

Mon	Tues	Wed	Thurs	Fri	Sat	Sun
1	2	3	4	5	6	7
8	9	10	11	12	13	14
15	16	17	18	19	20	21
22	23	24	25	26	27	28
29	30					

Ben has made a square around his birthday.

He notices that: $2 + 18 = 20$ and $3 + 17 = 20$

Question 1: Are there any others pairs of numbers in the square that add up to 20? List them.

Ben says: "I am very special! All the number pairs around my birthday add up to double my birth-date"

Pinky's birthday is on the 19th of June. She also decides to make a square just like Ben's.

Question 2: What does Pinky notice about the pairs of numbers around her birth-date? Explain.

Question 3: What about other birth-dates? What do you notice?

Illustrative Grade 2 Assessment Task for Lesson Plan for Term 2

WORKSHEET OPTION 2

Mon	Tues	Wed	Thurs	Fri	Sat	Sun
1	2	3	4	5	6	7
8	9	10	11	12	13	14
15	16	17	18	19	20	21
22	23	24	25	26	27	28
29	30					

Thandi has coloured the multiples of 6 on the calendar page:

6; 12; 18; 24; ____; ____; ____

Question 1: Write down the next three numbers in the pattern.

Question 2: Colour in two more patterns of multiples on the calendar.

Question 3: Write down the patterns that you have coloured in and extend so that there are 8 numbers in each pattern.

Samuel sees this pattern on the calendar page:

2; 10; 18; 26; ____; ____

Question 4: Write down the next two numbers in the pattern.

Question 5: Colour in one more pattern like Samuel's on the calendar.

Question 6: Write down the pattern that you have coloured in and extend so that there are 8 numbers in the pattern.

Checklist for Illustrative Grade 2 Assessment Task for Lesson Plan for Term 2

WORKSHEET: MARKETING MEMORANDUM FOR –

OPTION 1

- $4 + 16 = 20$
 $9 + 11 = 20$
- $11 + 27 = 38$
 $12 + 26 = 38$
 $13 + 25 = 38$
 $18 + 20 = 38$

 $38 = 2 \times 19$
- The same will be found for any birth-date. When you add the two opposite numbers, the answer will be double the middle number.

OPTION 2

- 30; 36; 42
- Two possible patterns include:
8; 16; 24;
7; 14; 21; 28
- 7; 14; 21; 28; 35; 42; 49; 56
8; 16; 24; 32; 40; 48; 56; 64
- 34; 42
- Possible examples include:
1; 9; 17; 25
3; 11; 19; 27
1; 10; 19; 28
- Possible examples include:
1; 9; 17; 25; **33; 41; 49; 57**
3; 11; 19; 27; **35; 43; 51; 59**
1; 10; 19; 28; **37; 46; 55; 64**

Illustrative Grade 2 Lesson Plan for Term 3

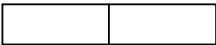
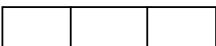
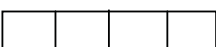
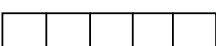
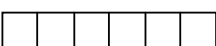
Term 3	
<p>CONTENT AREA Number, Operation and Relationships</p>	<p>MATHEMATICAL SKILLS AND CONCEPTS</p> <ul style="list-style-type: none"> • Orders, describes and compares common fractions including halves and quarters • Solves and explains solutions to practical problems that involve equal sharing and that lead to solutions that also include unitary fractions (e.g. $\frac{1}{4}$)
<p>ASSESSMENT TASK(S) Day 7: Written Recording: Worksheet and Marking Memorandum</p>	<p>RESOURCES</p> <ul style="list-style-type: none"> • Counters and counting frames, Flard cards • Problems • “Poster” with fraction wall and fraction names • Mat books, teacher’s record book • Seat work exercises
<p>LOOKING BACKWARDS: Learners should be familiar with:</p> <ul style="list-style-type: none"> • Solving problems by making their own plans • Equal sharing situations • Explaining their solution methods to the group 	<p>LOOKING FORWARDS:</p> <ul style="list-style-type: none"> • More equal sharing situations where different numbers of people share • Naming more fractions • Comparing fractions
SEQUENCE OF ACTIVITIES FOR GROUPS ON THE MAT	
<ul style="list-style-type: none"> • Every day: <ul style="list-style-type: none"> - Counting exercises - Up and down the number ladder - Flard card activities • First session with each group: Pose problems: <ol style="list-style-type: none"> 1. Siphon, Vuyani and Linda want to share 4 chocolate bars equally. Show how they must do it. 2. Tom, Thabo, Sam and Sara want to share 5 chocolate bars equally. Show how they must do it. • Second session with each group: Introduce poster with fraction wall: <p>If a chocolate bar is cut into two equal parts we call them halves </p> <p>If a chocolate bar is cut into three equal parts we call them thirds </p> <p>If a chocolate bar is cut into four equal parts we call them fourths </p> <p>If a chocolate bar is cut into five equal parts we call them fifths </p> <p>If a chocolate bar is cut into six equal parts we call them sixths </p> 	<p>Teach the fraction names as social knowledge. Revisit problems 1 and 2 (previous session) and give names to pieces.</p> <ul style="list-style-type: none"> • Third session with each group: Revisit problems 1 and 2: <ol style="list-style-type: none"> 3. Who gets more chocolate – Siphon or Tom? 4. What is bigger – one third of a chocolate bar or one fifth of a chocolate bar? Why? • In subsequent sessions with each group: Pose the problems: <ol style="list-style-type: none"> 1. Five friends share 6 vienna sausages equally. How much sausage will each get? Show how to do it. 2. Four friends share 9 sausages equally. How much sausage will each get? 3. This is a chocolate bar. How much will be one third of a chocolate bar? 4. This is a chocolate bar cut into equal parts. What do I call each of the parts? How do I know that? <div style="border: 1px solid black; width: 100px; height: 20px; margin: 10px auto;"></div>
SEATWORK ACTIVITIES	
<ul style="list-style-type: none"> • Number exercises: • Complete number sequences • Complete tables 	<ul style="list-style-type: none"> • Complete flow diagrams • Make the sides equal



Illustrative Grade 2 Assessment Task for Lesson Plan for Term 3

Written Task

Name: _____

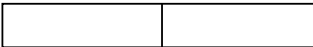
1. This chocolate bar is cut into equal pieces. 
What are the pieces called?

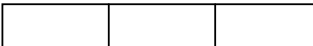
2. This chocolate bar is cut into equal pieces. 
What are the pieces called?

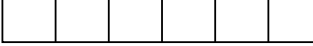
3. This chocolate bar is cut into equal pieces. 
What are the pieces called?

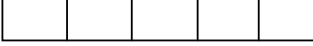
4. This chocolate bar is cut into equal pieces. 
What are the pieces called?

5. This is a sausage. 
Show one-fourth (one quarter) of the sausage.

6. What is bigger: one third of a chocolate bar or one fifth of a chocolate bar?

7. Three children share 7 chocolate bars equally. Show how they must do it.
How much chocolate will each child get?

8. Five children share 6 sausages equally. How much sausage will each child get?

Memorandum for Illustrative Grade 2 Assessment Task for Lesson Plan for Term 3

Written Task

Marking memorandum:

1. Halves
2. Thirds
3. Sixths
4. Fifths
- 5.

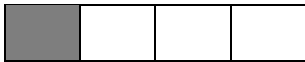

6. One third of a chocolate bar.
7. Show drawing of 7 chocolate bars shared equally by three children.
Each gets 2 whole chocolates and one small piece.
Each small piece is called a third.
Each child gets 2 chocolate bars and a third of a chocolate bar
8. Each gets 1 sausage and one fifth of a sausage.
(They may show a drawing, but could also just give the answer.)



Appendix B – Flard cards

Instructions

- Photocopy/print the Flard cards onto sheets of card board (240 to 300 gsm).
- Laminate the board
- Cut out the Flard cards by cutting very accurately along the grey lines
- Place one set of cards into a ziplock packet (e.g. Bank packet)

Notes

- Until late in Grade 3 or early in Grade 4 you will not need the thousands cards.
- To make the sorting of the cards easier you may want to number the sets by writing a number on the back of each of the cards in a set – best done before laminating.

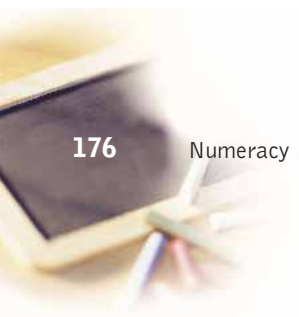

1	1 0	1 0 0	1 0 0 0
2	2 0	2 0 0	2 0 0 0
3	3 0	3 0 0	3 0 0 0
4	4 0	4 0 0	4 0 0 0
5	5 0	5 0 0	5 0 0 0
6	6 0	6 0 0	6 0 0 0
7	7 0	7 0 0	7 0 0 0
8	8 0	8 0 0	8 0 0 0
9	9 0	9 0 0	9 0 0 0



Bibliography

1. Department of Basic Education National Curriculum Statement (NCS) (2012): Curriculum and Assessment Policy Statement (CAPS): Mathematics Grade R
2. Department of Basic Education National Curriculum Statement (NCS) (2012): Curriculum and Assessment Policy Statement (CAPS): Mathematics Grades 1–3
3. Department of Basic Education National Curriculum Statement (NCS) (2012): National Policy pertaining to the Programme and Promotion Requirements of the National Curriculum Statement Grades R–12
4. Department of Basic Education National Curriculum Statement (NCS) (2012): National Protocol for Assessment Grades R–12
5. Department of Education (2002) Revised National Curriculum Statement Grades R–9 Mathematics, Government Printer, Pretoria
6. Department of Education, (2007) Assessment Guidelines for Foundation Phase Grades R–3, Government Printer, Pretoria
7. Department of Education (2002) Revised National Curriculum Statement Grades R–9 (Schools) Teacher’s Guide for the Development of Learning Programmes, Government Printer, Pretoria
8. Kamii, C.K. with Clarke (1985) Young Children Reinvent Arithmetic Teachers College Press, New York, N.Y. pp 269
9. Kilpatrick, K., Swafford, J. and Findell, B (Ed) (2001) Adding It Up Helping Children Learn Mathematics National Academy Press, Washington D.C.
10. Van Hiele, P.M. (1999) Developing Geometric Thinking through Activities That Begin with Play in Teaching Children Mathematics pp 310–316 National Council for Teachers



